

Katalog części zamiennych dla MAZAK®

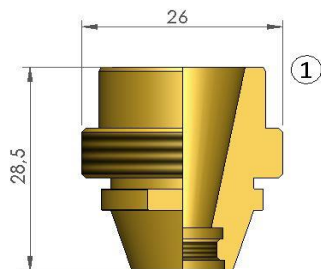

POZ	NUMER REFERENCYJNY	NAZWA
1	46603350510	MAZAK® NOZZLE ADAPTER BODY

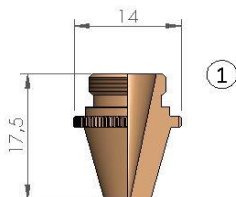

POZ	NUMER REFERENCYJNY	NAZWA
1	46603350508	MAZAK® NOZZLE Ø 0.8
	46603350511	MAZAK® NOZZLE Ø 1.0
	46603350512	MAZAK® NOZZLE Ø 1.2
	4660335052B	MAZAK® NOZZLE Ø 1.5
	46603350517	MAZAK® NOZZLE Ø 1.7
	46603350517-1.8	MAZAK® NOZZLE Ø 1.8
	4660335052C	MAZAK® NOZZLE Ø 2.0
	46603350522-2.2	MAZAK® NOZZLE Ø 2.2
	46603350525	MAZAK® NOZZLE Ø 2.5
	46603350530	MAZAK® NOZZLE Ø 3.0
	46603350530-3,5 Q660335052F	MAZAK® NOZZLE Ø 3.5
	46603350530-4.0	MAZAK® NOZZLE Ø 4.0
	46603350530-4.5	MAZAK® NOZZLE Ø 4.5
	46603350530-5.0	MAZAK® NOZZLE Ø 5.0

Katalog części zamiennych dla MAZAK®

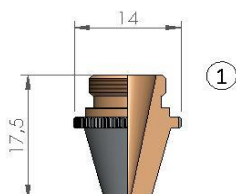

POZ	NUMER REFERENCYJNY	NAZWA
1	46603350508	MAZAK® NOZZLE Ø 0.8 CP
	46603350511	MAZAK® NOZZLE Ø 1.0 CP
	46603350512	MAZAK® NOZZLE Ø 1.0 CP
	4660335052B	MAZAK® NOZZLE Ø 1.5 CP
	46603350517	MAZAK® NOZZLE Ø 1.7 CP
	46603350517-1.8	MAZAK® NOZZLE Ø 1.8 CP
	4660335052C	MAZAK® NOZZLE Ø 2.0 CP
	46603350522-2.2	MAZAK® NOZZLE Ø 2.2 CP
	46603350525	MAZAK® NOZZLE Ø 2.5 CP
	46603350530	MAZAK® NOZZLE Ø 3.0 CP
	46603350530-3,5 Q660335052F	MAZAK® NOZZLE Ø 3.5 CP
	46603350530-4.0	MAZAK® NOZZLE Ø 4.0 CP
	46603350530-4.5	MAZAK® NOZZLE Ø 4.5 CP
	46603350530-5.0	MAZAK® NOZZLE Ø 5.0 CP

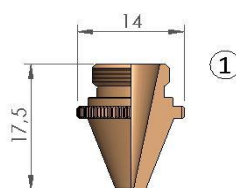

POZ	NUMER REFERENCYJNY	NAZWA
1	46603350521-0,8	MAZAK® NOZZLE Ø 0.8
	46603350521-1,0	MAZAK® NOZZLE Ø 1.0
	46603350521-1,2	MAZAK® NOZZLE Ø 1.2
	4660335052B 1.5	MAZAK® NOZZLE Ø 1.5
	46603350521-1,7	MAZAK® NOZZLE Ø 1.7
	46603350522-2,0	MAZAK® NOZZLE Ø 2.0
	46603350522-2,5	MAZAK® NOZZLE Ø 2.5
	46683301281-3.0	MAZAK® NOZZLE Ø 3.0

Katalog części zamiennych dla MAZAK®

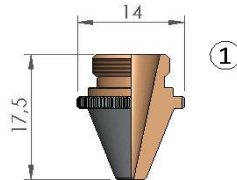

POZ	NUMER REFERENCYJNY	NAZWA
1	46603350521-0,8	MAZAK® NOZZLE Ø 0.8 CP
	46603350521-1,0	MAZAK® NOZZLE Ø 1.0 CP
	46603350521-1,2	MAZAK® NOZZLE Ø 1.2 CP
	4660335052B 1.5	MAZAK® NOZZLE Ø 1.5 CP
	46603350521-1,7	MAZAK® NOZZLE Ø 1.7 CP
	46603350522-2,0	MAZAK® NOZZLE Ø 2.0 CP
	46603350522-2,5	MAZAK® NOZZLE Ø 2.5 CP
	46683301281-3.0	MAZAK® NOZZLE Ø 3.0 CP

Katalog części zamiennych dla MAZAK®

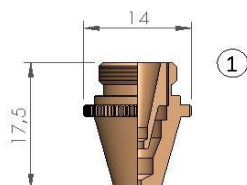

POZ	NUMER REFERENCYJNY	NAZWA
1		MAZAK® DOUBLE NOZZLE Ø 1.0
		MAZAK® DOUBLE NOZZLE Ø 1.2
		MAZAK® DOUBLE NOZZLE Ø 1.5
		MAZAK® DOUBLE NOZZLE Ø 1.7
		MAZAK® DOUBLE NOZZLE Ø 1.8
		MAZAK® DOUBLE NOZZLE Ø 2.0
		MAZAK® DOUBLE NOZZLE Ø 2.2
		MAZAK® DOUBLE NOZZLE Ø 2.5
	MAZAK® DOUBLE NOZZLE Ø 3.0	

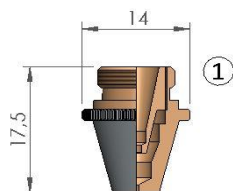

POZ	NUMER REFERENCYJNY	NAZWA
1		MAZAK® DOUBLE NOZZLE Ø 1.0 CP
		MAZAK® DOUBLE NOZZLE Ø 1.2 CP
		MAZAK® DOUBLE NOZZLE Ø 1.5 CP
		MAZAK® DOUBLE NOZZLE Ø 1.7 CP
		MAZAK® DOUBLE NOZZLE Ø 1.8 CP
		MAZAK® DOUBLE NOZZLE Ø 2.0 CP
		MAZAK® DOUBLE NOZZLE Ø 2.2 CP
		MAZAK® DOUBLE NOZZLE Ø 2.5 CP
		MAZAK® DOUBLE NOZZLE Ø 3.0 CP

Katalog części zamiennych dla MAZAK®

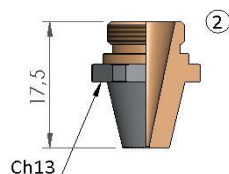
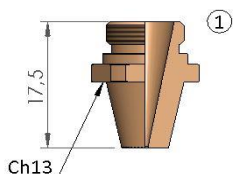

POZ	NUMER REFERENCYJNY	NAZWA
1		MAZAK® HEXAGONAL NOZZLE Ø 0.8
		MAZAK® HEXAGONAL NOZZLE Ø 1.0
		MAZAK® HEXAGONAL NOZZLE Ø 1.2
		MAZAK® HEXAGONAL NOZZLE Ø 1.5
		MAZAK® HEXAGONAL NOZZLE Ø 1.7
		MAZAK® HEXAGONAL NOZZLE Ø 1.8
		MAZAK® HEXAGONAL NOZZLE Ø 2.0
		MAZAK® HEXAGONAL NOZZLE Ø 2.2
		MAZAK® HEXAGONAL NOZZLE Ø 2.5
		MAZAK® HEXAGONAL NOZZLE Ø 3.0
		MAZAK® HEXAGONAL NOZZLE Ø 3.5
		MAZAK® HEXAGONAL NOZZLE Ø 4.0
	2	
		MAZAK® HEXAGONAL NOZZLE Ø 1.0 CP
		MAZAK® HEXAGONAL NOZZLE Ø 1.2 CP
		MAZAK® HEXAGONAL NOZZLE Ø 1.5 CP
		MAZAK® HEXAGONAL NOZZLE Ø 1.7 CP
		MAZAK® HEXAGONAL NOZZLE Ø 1.8 CP
		MAZAK® HEXAGONAL NOZZLE Ø 2.0 CP
		MAZAK® HEXAGONAL NOZZLE Ø 2.2 CP
		MAZAK® HEXAGONAL NOZZLE Ø 2.5 CP
		MAZAK® HEXAGONAL NOZZLE Ø 3.0 CP
		MAZAK® HEXAGONAL NOZZLE Ø 3.5 CP
	MAZAK® HEXAGONAL NOZZLE Ø 4.0 CP	

Katalog części zamiennych dla MAZAK®



POZ	NUMER REFERENCYJNY	NAZWA
1		MAZAK® HEXAGONAL DOUBLE NOZZLE Ø 1.2
		MAZAK® HEXAGONAL DOUBLE NOZZLE Ø 1.5
		MAZAK® HEXAGONAL DOUBLE NOZZLE Ø 1.8
		MAZAK® HEXAGONAL DOUBLE NOZZLE Ø 2.0
		MAZAK® HEXAGONAL DOUBLE NOZZLE Ø 2.2
		MAZAK® HEXAGONAL DOUBLE NOZZLE Ø 2.5
		MAZAK® HEXAGONAL DOUBLE NOZZLE Ø 3.0
2		MAZAK® HEXAGONAL DOUBLE NOZZLE Ø 1.2 CP
		MAZAK® HEXAGONAL DOUBLE NOZZLE Ø 1.5 CP
		MAZAK® HEXAGONAL DOUBLE NOZZLE Ø 1.8 CP
		MAZAK® HEXAGONAL DOUBLE NOZZLE Ø 2.0 CP
		MAZAK® HEXAGONAL DOUBLE NOZZLE Ø 2.2 CP
		MAZAK® HEXAGONAL DOUBLE NOZZLE Ø 2.5 CP
		MAZAK® HEXAGONAL DOUBLE NOZZLE Ø 3.0 CP

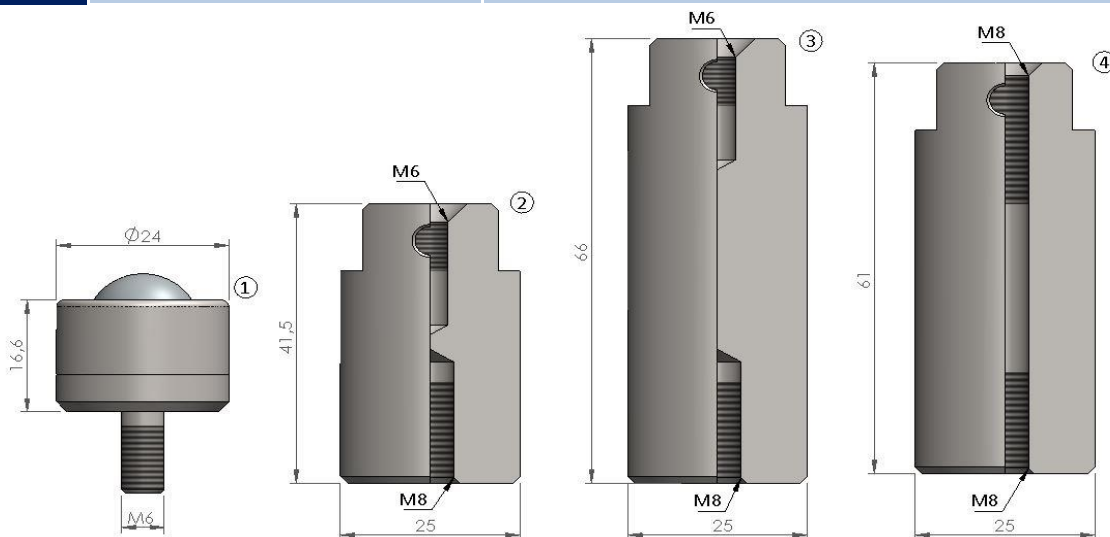

POZ	NUMER REFERENCYJNY	NAZWA
1	Z21KV000580	MAZAK® FREE TABLE ROLLER
2	46575100321	MAZAK® BLOCK STAINLESS STEEL
3	46705100050	MAZAK® LONG BLOCK STAINLESS STEEL
4	46775100101	MAZAK® BLOCK STAINLESS STEEL

W celu uzyskania informacji o produktach niewymienionych w katalogu, zapraszamy do kontaktu. Numery według producenta zostały umieszczone tylko i wyłącznie w celu ułatwienia prawidłowej specyfikacji towaru.

Katalog części zamiennych dla MAZAK®

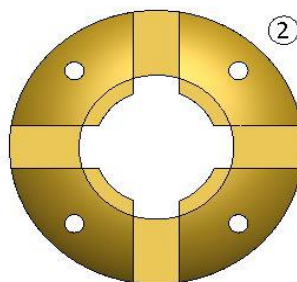
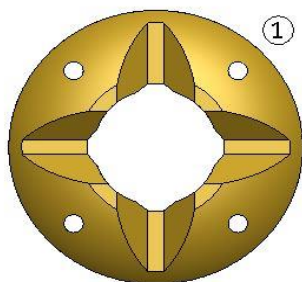

POZ	NUMER REFERENCYJNY	NAZWA
1	46602350080	MAZAK® STYLUS FOOT H9 BRASS
2		MAZAK® STYLUS FOOT H9 BRASS

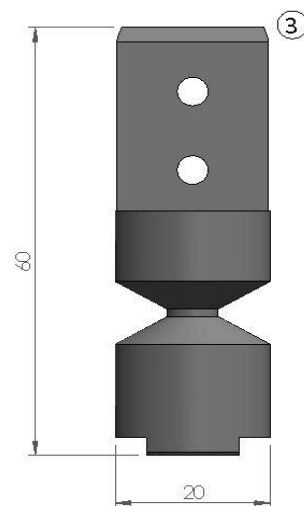
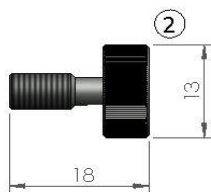
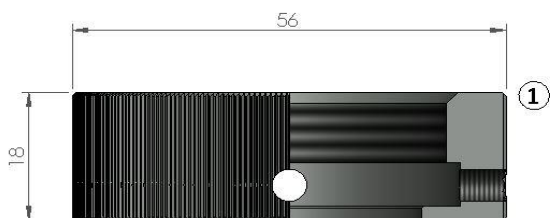

POZ	NUMER REFERENCYJNY	NAZWA
1	46683300930	MAZAK® RING
2	46683300032	MAZAK® BOLT M5 x.05
3	36682300280	MAZAK® ALUMINIUM BREAK-AWAY BAR L60 - M8

Katalog części zamiennych dla MAZAK®

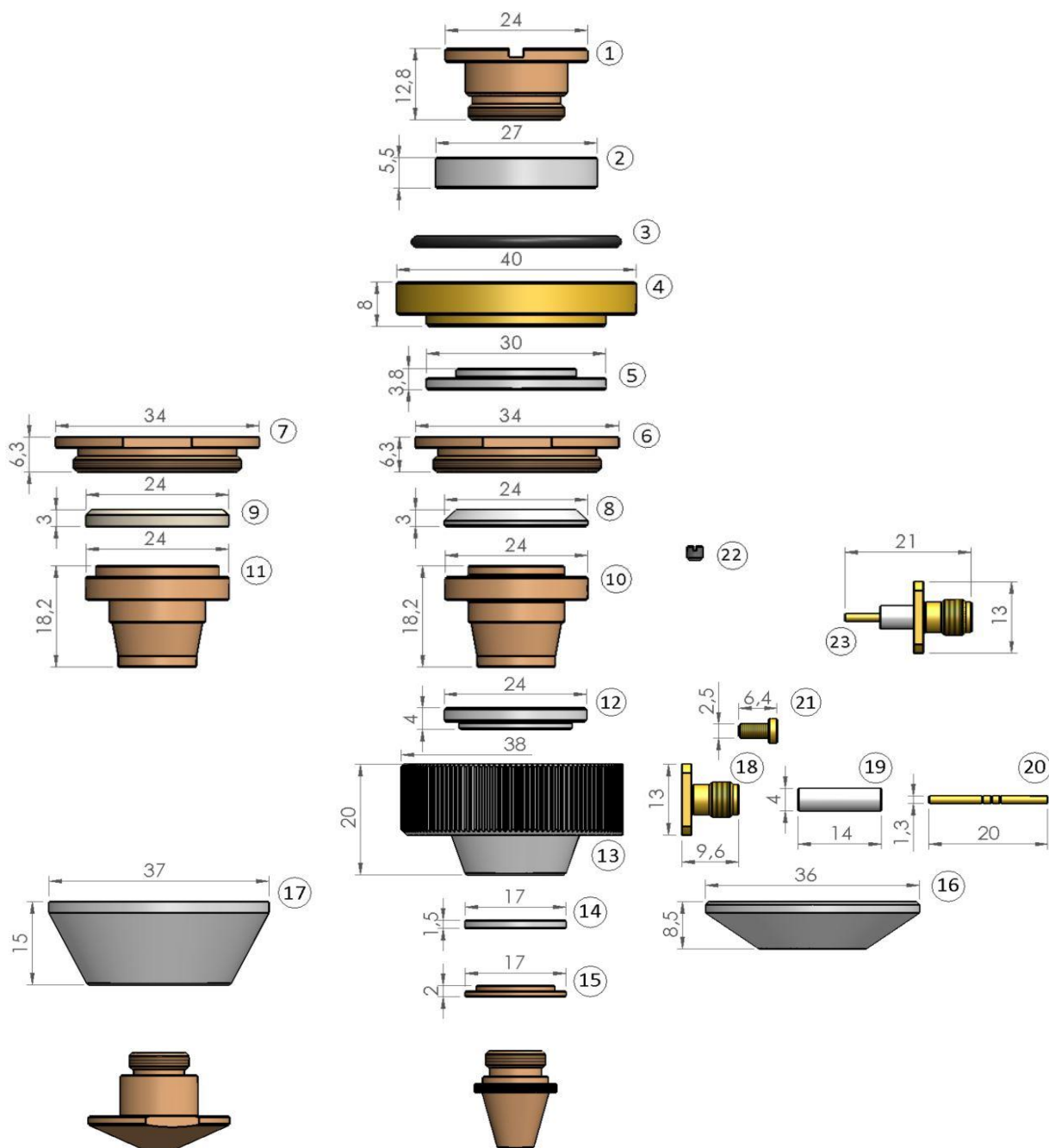

Katalog części zamiennych dla MAZAK®

POZ	NUMER REFERENCYJNY	NAZWA
1	46683301110	MAZAK® NOZZLE HOLDER
2	46683301080	MAZAK® PTFE SPACER 27x5.5
	46683301080, 46683302081	MAZAK® SPECIAL SPACER 27X5.5 - PEEK
	46683301080	MAZAK® CERAMIC SPACER 27X5.5
3	J2600S03200	MAZAK® O'RING EXTERNAL BASE - RUBBER
4	46683301070	MAZAK® BRASS BASE
5	46683301090	MAZAK® PTFE SPACER 30x4
	46683301090, 46683302091	MAZAK® SPECIAL SPACER 30X4 - PEEK
	46683301090	MAZAK® CERAMIC SPACER 30X4
6	46683301100	MAZAK® COPPER NUT
7	46773300510	MAZAK® COPPER RING SUPPORT
8	46683301120	MAZAK® PTFE SPACER 24x3
	46683301120	MAZAK® SPECIAL SPACER 24x3 - PEEK
	46683301120	MAZAK® CERAMIC SPACER 24X3
9	46773300710	MAZAK® CERAMIC SPACER 24x3
	46773300710	MAZAK® CERAMIC SPACER 24x3
10	46683300850	MAZAK® COPPER NOZZLE HOLDER
11	46773300720, 46773300721	MAZAK® COPPER NOZZLE HOLDER
12	46683301130	MAZAK® PTFE SPACER 24x4
	46683301130	MAZAK® SPECIAL SPACER 24X4 - PEEK
	46683301130	MAZAK® CERAMIC SPACER 24X4
13	46683301140	MAZAK® ALUMINIUM BODY
14	46683301150	MAZAK® PTFE SPACER 17X1.5
15	46683301160	MAZAK® COPPER RING 17X2
16	46683301930	MAZAK® PTFE PROTECTION
	46683301930P	MAZAK® SPECIAL PROTECTION - PEEK
17	46683301841	MAZAK® PTFE SPACER
18		MAZAK® CONNECTOR
19	46683300030	MAZAK® CONNECTING PTFE PIPE
20	46683301170	MAZAK® CONTACT
21	46683300000	MAZAK® SCREW (4PCS)
22	46683301180	MAZAK® SCREW FOR CONTACT SLOTTED HEAD
23	46683301171	MAZAK® CONNECTOR ASSEMBLY

Katalog części zamiennych dla MAZAK®

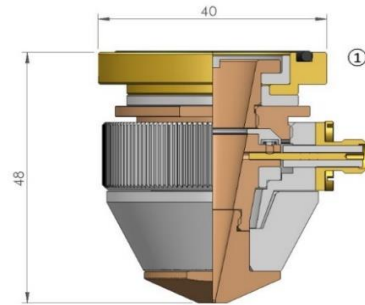

POZ	NUMER REFERENCYJNY	NAZWA
1		MAZAK® HEAD W/PTFE SPACER
		MAZAK® HEAD W/LONG LIFE SPACER
		MAZAK® HEAD W/CERAMIC SPACER

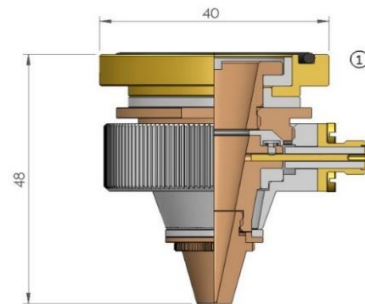

POZ	NUMER REFERENCYJNY	NAZWA
1		MAZAK® HEAD W/PTFE SPACER
		MAZAK® HEAD W/LONG LIFE SPACER
		MAZAK® HEAD W/CERAMIC SPACER

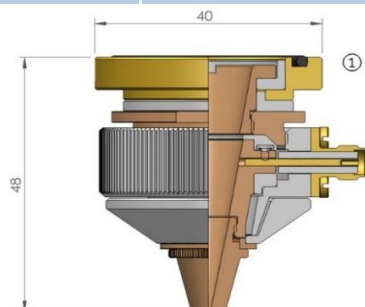

POZ	NUMER REFERENCYJNY	NAZWA
1		MAZAK® HEAD W/PTFE SPACER
		MAZAK® HEAD W/LONG LIFE SPACER
		MAZAK® HEAD W/CERAMIC SPACER

Katalog części zamiennych dla MAZAK®

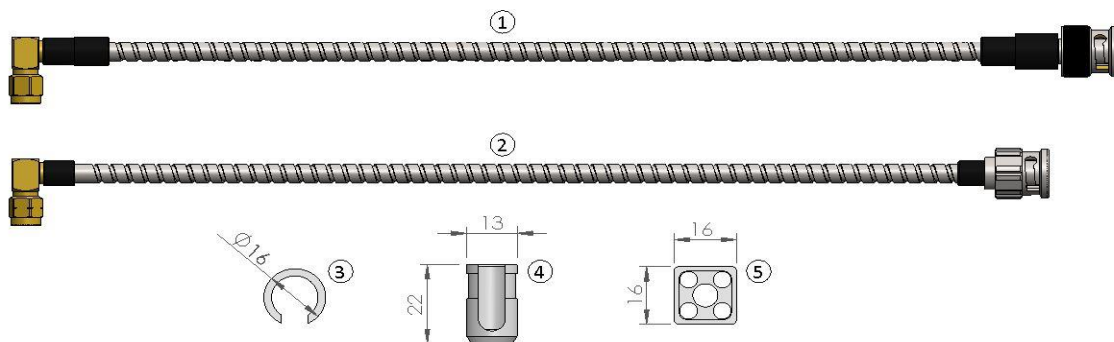

POZ	NUMER REFERENCYJNY	NAZWA
1	46683301980	MAZAK® CONNECTING CABLE FOR SENSOR HEAD
2	46683301330	MAZAK® CONNECTING CABLE FOR SENSOR HEAD 33cm
3	46683301870, 46683301920	MAZAK® COVER CLIPS PTFE
4	46683301860, 46683301910	MAZAK® CONNECTOR COVER FOR CABLE PTFE
5	46683301851	MAZAK® CONNECTOR COVER PTFE

Katalog części zamiennych dla MAZAK®

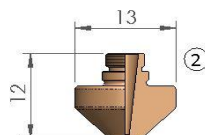
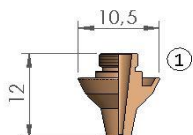

POZ	NUMER REFERENCYJNY	NAZWA
1	46713300290-10	MAZAK® NOZZLE 3D Ø 1.0
	Q6713330410-46713300290-12	MAZAK® NOZZLE 3D Ø 1.2
	46713300290-15-P0352-381-00015	MAZAK® NOZZLE 3D Ø 1.5
		MAZAK® NOZZLE 3D Ø 1.8
	46713300280-P0352-382-00020	MAZAK® NOZZLE 3D Ø 2.0
	46713300280-25	MAZAK® NOZZLE 3D Ø 2.5
	46713300280-30-46713300430	MAZAK® NOZZLE 3D Ø 3.0
	46713300280-35	MAZAK® NOZZLE 3D Ø 3.5
2		MAZAK® NOZZLE 2D Ø 1.0
	46713300310	MAZAK® NOZZLE 2D Ø 1.2
	P0352-386-00015	MAZAK® NOZZLE 2D Ø 1.5
		MAZAK® NOZZLE 2D Ø 1.8
	46713300300-P0352-387-00020	MAZAK® NOZZLE 2D Ø 2.0
	46713300300- 25	MAZAK® NOZZLE 2D Ø 2.5
	46713300300 -30	MAZAK® NOZZLE 2D Ø 3.0

Katalog części zamiennych dla MAZAK®

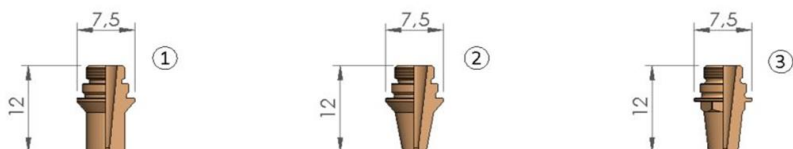

POZ	NUMER REFERENCYJNY	NAZWA
1	281005-P0352-323-00010	MAZAK®NOZZLE Ø1.0 ZK
	281034-P0352-324-00012	MAZAK®NOZZLE Ø1.2 ZK
	281013-P0352-325-00015	MAZAK®NOZZLE Ø1.5 ZK
	280899-P0352-326-00018	MAZAK®NOZZLE Ø1.8 ZK
	350044.3-P0352-327-00020	MAZAK®NOZZLE Ø2.0 ZK
	P0352-328-00025	MAZAK®NOZZLE Ø2.5 ZK
2	281006-P0352-333-00010	MAZAK®NOZZLE Ø 1.0 KK
	281030-P0352.334.00012	MAZAK®NOZZLE Ø 1.2 KK
	281031-P0352.335.00015	MAZAK®NOZZLE Ø 1.5 KK
	280898-P0352.336.00018	MAZAK®NOZZLE Ø 1.8 KK
	P0352.336.00020	MAZAK®NOZZLE Ø 2.0 KK
3		PRECITEC® NOZZLE DE M1.5 KS 1.0 HEX
		PRECITEC® NOZZLE DE M1.5 KS 1.2 HEX
	P0491-1001-00015	PRECITEC® NOZZLE DE M1.5 KS 1.5 HEX
	P0491-1002-00020	PRECITEC® NOZZLE DE M1.5 KS 2.0 HEX

Katalog części zamiennych dla MAZAK®

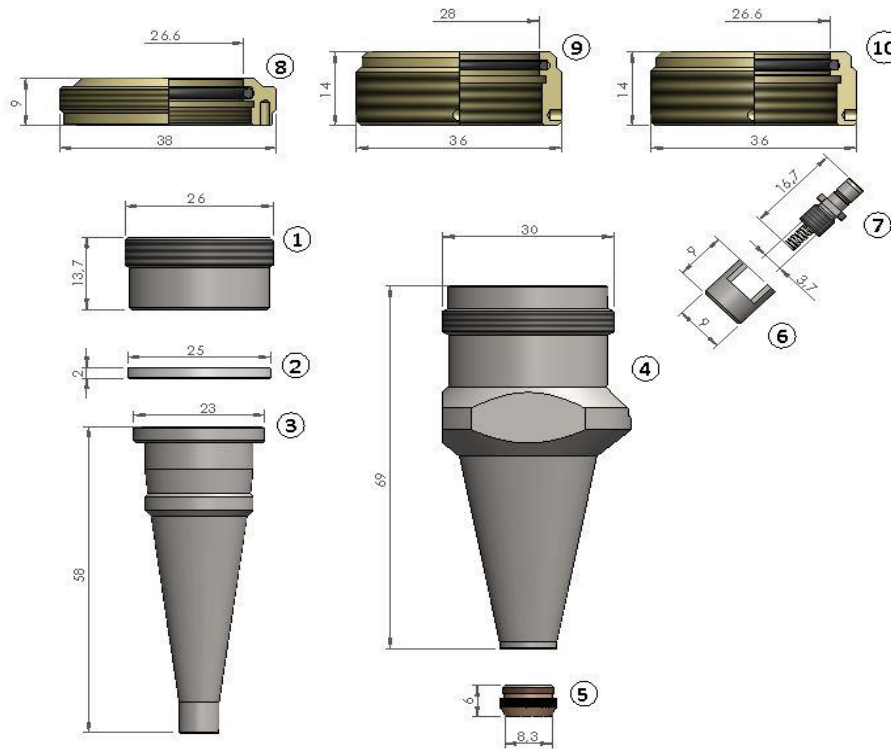

POZ	NUMER REFERENCYJNY	NAZWA
1	46713330940	MAZAK® TORCH INNER TOP
2	46713330960	MAZAK® WASHER FOR CONE
3	46713330930	MAZAK® INNER SENSOR CONE
4	46713331240	MAZAK® SENSOR CONE
5	46713300321-P0352-311-00001	MAZAK® VESPEL NUT - SPACE GEAR
6	46713330951	MAZAK® CONNECTOR CAP
7	46713331111	MAZAK® CONNECTOR
8	P0492-702-00001-29100021	PRECITEC® INSULATING RING - plastic
9	46713330920	MAZAK® INSULATION RING
10	46713330200	MAZAK® 5-AXIS INSULATOR

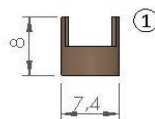

POZ	NUMER REFERENCYJNY	NAZWA
1	46713300390	PRECITEC® CONNECTOR PROTECTOR

Katalog części zamiennych dla MAZAK®

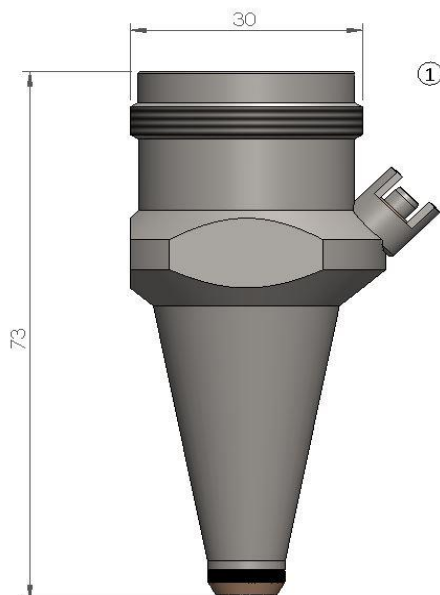

POZ	NUMER REFERENCYJNY	NAZWA
1		MAZAK® HEAD W/CERAMIC SPACER



POZ	NUMER REFERENCYJNY	NAZWA
1	281386 P0360-155-00500	MAZAK® ELECTRODE CABLE



POZ	NUMER REFERENCYJNY	NAZWA
1	46743300181	MAZAK® CONNECTING CABLE FOR SENSOR HEAD L=33CM

Katalog części zamiennych dla MAZAK®

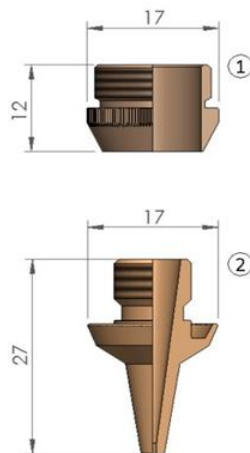

POZ	NUMER REFERENCYJNY	NAZWA
1	46713331280	MAZAK® NUT
2		MAZAK®NOZZLE 3D Ø1,0
	46713331320	MAZAK®NOZZLE 3D Ø1,2
	46713331310	MAZAK®NOZZLE 3D Ø1,5
		MAZAK®NOZZLE 3D Ø1,8
	46713331300	MAZAK®NOZZLE 3D Ø2,0
	46713331330	MAZAK®NOZZLE 3D Ø2,5
	46713331290	MAZAK®NOZZLE 3D Ø3,0
		MAZAK®NOZZLE 3D Ø3,5

Katalog części zamiennych dla MAZAK®

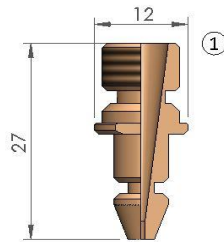

POZ	NUMER REFERENCYJNY	NAZWA
1	06073300691	MAZAK® NOZZLE 3D LONG AIR NOZZLE Ø 1,0
	06073300800	MAZAK® NOZZLE 3D LONG AIR NOZZLE Ø 1,2
	06073300810	MAZAK® NOZZLE 3D LONG AIR NOZZLE Ø 1,5
	06073300552	MAZAK® NOZZLE 3D LONG AIR NOZZLE Ø 2,0
	06073300830	MAZAK® NOZZLE 3D LONG AIR NOZZLE Ø 2.5
	06073300711	MAZAK® NOZZLE 3D LONG AIR NOZZLE Ø 3,0
	06073300850	MAZAK® NOZZLE 3D LONG AIR NOZZLE Ø 4.0

Katalog części zamiennych dla MAZAK®

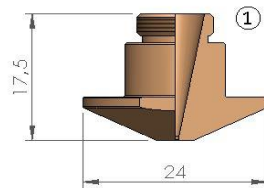

POZ	NUMER REFERENCYJNY	NAZWA
1		MAZAK® NOZZLE Ø 1.0
		MAZAK® NOZZLE Ø 1.2
	46683301950	MAZAK® NOZZLE Ø 1.5
	46683301821	MAZAK® NOZZLE Ø 2.0
	46683301960	MAZAK® NOZZLE Ø 2.5
	46683301970	MAZAK® NOZZLE Ø 3.0
		MAZAK® NOZZLE Ø 3.5
		MAZAK® NOZZLE Ø 4.0
		MAZAK® NOZZLE Ø 4.5

Katalog części zamiennych dla MAZAK®

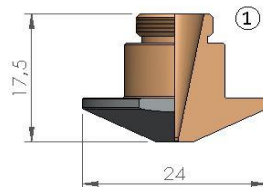

POZ	NUMER REFERENCYJNY	NAZWA
1		MAZAK® NOZZLE Ø 1.0 CP
		MAZAK® NOZZLE Ø 1.2 CP
	46683301950	MAZAK® NOZZLE Ø 1.5 CP
	46683301821	MAZAK® NOZZLE Ø 2.0 CP
	46683301960	MAZAK® NOZZLE Ø 2.5 CP
	46683301970	MAZAK® NOZZLE Ø 3.0 CP
		MAZAK® NOZZLE Ø 3.5 CP
		MAZAK® NOZZLE Ø 4.0 CP
		MAZAK® NOZZLE Ø 4.5 CP

Katalog części zamiennych dla MAZAK®

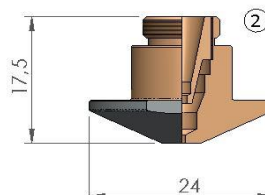
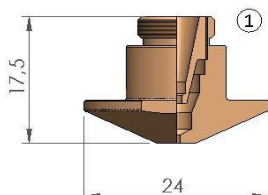

POZ	NUMER REFERENCYJNY	NAZWA
1		MAZAK® DOUBLE NOZZLE Ø 1.0
		MAZAK® DOUBLE NOZZLE Ø 1.2
	46683302420	MAZAK® DOUBLE NOZZLE Ø 1.5
		MAZAK® DOUBLE NOZZLE Ø 1.8
	46683302430	MAZAK® DOUBLE NOZZLE Ø 2.0
	46683302440	MAZAK® DOUBLE NOZZLE Ø 2.5
2	46683302450	MAZAK® DOUBLE NOZZLE Ø 3.0
		MAZAK® DOUBLE NOZZLE Ø 1.0 CP
		MAZAK® DOUBLE NOZZLE Ø 1.2 CP
	46683302420	MAZAK® DOUBLE NOZZLE Ø 1.5 CP
		MAZAK® DOUBLE NOZZLE Ø 1.8 CP
	46683302430	MAZAK® DOUBLE NOZZLE Ø 2.0 CP
	46683302440	MAZAK® DOUBLE NOZZLE Ø 2.5 CP
46683302450	MAZAK® DOUBLE NOZZLE Ø 3.0 CP	

Katalog części zamiennych dla MAZAK®

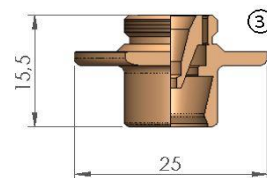
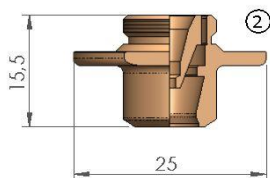
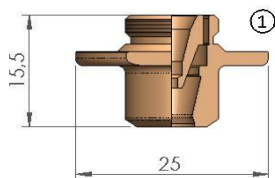

POZ	NUMER REFERENCYJNY	NAZWA
1	Q6283300030	MAZAK® DOUBLE NOZZLE SMOOTH Ø 6.0
2	Q6283300020	MAZAK® DOUBLE NOZZLE SMOOTH Ø 7.5
3	Q6283300010	MAZAK® DOUBLE NOZZLE SMOOTH Ø 9.5

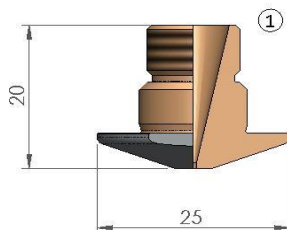

POZ	NUMER REFERENCYJNY	NAZWA
1		MAZAK® NOZZLE Ø 0.8 CP
		MAZAK® NOZZLE Ø 1.0 CP
	46143304471	MAZAK® NOZZLE Ø 1.2 CP
	46143304451	MAZAK® NOZZLE Ø 1.5 CP
		MAZAK® NOZZLE Ø 1.8 CP
	46143304461	MAZAK® NOZZLE Ø 2.0 CP
	46143304480	MAZAK® NOZZLE Ø 2.5 CP
	46143304490	MAZAK® NOZZLE Ø 3.0 CP
	46143304500	MAZAK® NOZZLE Ø 3.5 CP
	46143304510	MAZAK® NOZZLE Ø 4.0 CP

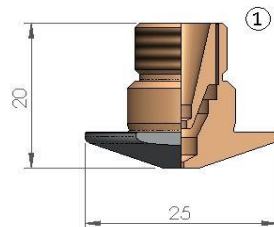
Katalog części zamiennych dla MAZAK®

POZ	NUMER REFERENCYJNY	NAZWA
1		MAZAK® DOUBLE NOZZLE Ø 1.2 CP
	46143306450	MAZAK® DOUBLE NOZZLE Ø 1.5 CP
	46143306460	MAZAK® DOUBLE NOZZLE Ø 2.0 CP
	46143306480	MAZAK® DOUBLE NOZZLE Ø 2.5 CP
	46143306490	MAZAK® DOUBLE NOZZLE Ø 3.0 CP
	46143306500	MAZAK® DOUBLE NOZZLE Ø 3.5 CP
		MAZAK® DOUBLE NOZZLE Ø 4.0 CP

Katalog części zamiennych dla MAZAK®

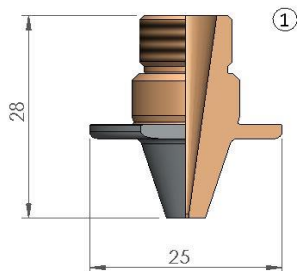

POZ	NUMER REFERENCYJNY	NAZWA
1		MAZAK® NOZZLE SLIM Ø 0.8 CP
		MAZAK® NOZZLE SLIM Ø 1.0 CP
	46143310343	MAZAK® NOZZLE SLIM Ø 1.2 CP
	46143310353	MAZAK® NOZZLE SLIM Ø 1.5 CP
		MAZAK® NOZZLE SLIM Ø 1.8 CP
	46143310363	MAZAK® NOZZLE SLIM Ø 2.0 CP
		MAZAK® NOZZLE SLIM Ø 2.2 CP
	46143310373	MAZAK® NOZZLE SLIM Ø 2.5 CP
	46143310383	MAZAK® NOZZLE SLIM Ø 3.0 CP
	46143310393	MAZAK® NOZZLE SLIM Ø 3.5 CP
	46143310403	MAZAK® NOZZLE SLIM Ø 4.0 CP

Katalog części zamiennych dla MAZAK®

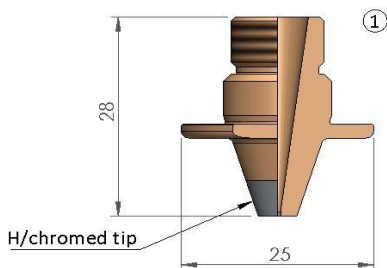

POZ	NUMER REFERENCYJNY	NAZWA
1		MAZAK® NOZZLE SLIM Ø 0.8 CP
		MAZAK® NOZZLE SLIM Ø 1.0 CP
	46143310343	MAZAK® NOZZLE SLIM Ø 1.2 CP
	46143310353	MAZAK® NOZZLE SLIM Ø 1.5 CP
		MAZAK® NOZZLE SLIM Ø 1.8 CP
	46143310363	MAZAK® NOZZLE SLIM Ø 2.0 CP
		MAZAK® NOZZLE SLIM Ø 2.2 CP
	46143310373	MAZAK® NOZZLE SLIM Ø 2.5 CP
	46143310383	MAZAK® NOZZLE SLIM Ø 3.0 CP
	46143310393	MAZAK® NOZZLE SLIM Ø 3.5 CP
	46143310403	MAZAK® NOZZLE SLIM Ø 4.0 CP

Katalog części zamiennych dla MAZAK®

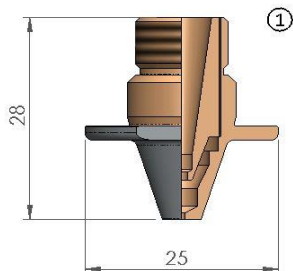

POZ	NUMER REFERENCYJNY	NAZWA
1		MAZAK® DOUBLE NOZZLE SLIM Ø 0.8 CP
		MAZAK® DOUBLE NOZZLE SLIM Ø 1.0 CP
		MAZAK® DOUBLE NOZZLE SLIM Ø 1.2 CP
	36143311500	MAZAK® DOUBLE NOZZLE SLIM Ø 1.5 CP
		MAZAK® DOUBLE NOZZLE SLIM Ø 1.8 CP
	36143311510	MAZAK® DOUBLE NOZZLE SLIM Ø 2.0 CP
		MAZAK® DOUBLE NOZZLE SLIM Ø 2.2 CP
	36143311520	MAZAK® DOUBLE NOZZLE SLIM Ø 2.5 CP
	36143311530	MAZAK® DOUBLE NOZZLE SLIM Ø 3.0 CP
	36143312380	MAZAK® DOUBLE NOZZLE SLIM Ø 3.5 CP
	36143312390	MAZAK® DOUBLE NOZZLE SLIM Ø 4.0 CP
		MAZAK® DOUBLE NOZZLE SLIM Ø 4.5 CP
		MAZAK® DOUBLE NOZZLE SLIM Ø 5.0 CP

Katalog części zamiennych dla MAZAK®

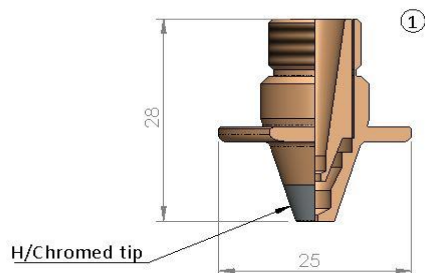

POZ	NUMER REFERENCYJNY	NAZWA
1		MAZAK® DOUBLE NOZZLE SLIM Ø 0.8 CP
		MAZAK® DOUBLE NOZZLE SLIM Ø 1.0 CP
		MAZAK® DOUBLE NOZZLE SLIM Ø 1.2 CP
	36143311500	MAZAK® DOUBLE NOZZLE SLIM Ø 1.5 CP
		MAZAK® DOUBLE NOZZLE SLIM Ø 1.8 CP
	36143311510	MAZAK® DOUBLE NOZZLE SLIM Ø 2.0 CP
		MAZAK® DOUBLE NOZZLE SLIM Ø 2.2 CP
	36143311520	MAZAK® DOUBLE NOZZLE SLIM Ø 2.5 CP
	36143311530	MAZAK® DOUBLE NOZZLE SLIM Ø 3.0 CP
	36143312380	MAZAK® DOUBLE NOZZLE SLIM Ø 3.5 CP
	36143312390	MAZAK® DOUBLE NOZZLE SLIM Ø 4.0 CP
		MAZAK® DOUBLE NOZZLE SLIM Ø 4.5 CP
		MAZAK® DOUBLE NOZZLE SLIM Ø 5.0 CP

Katalog części zamiennych dla MAZAK®

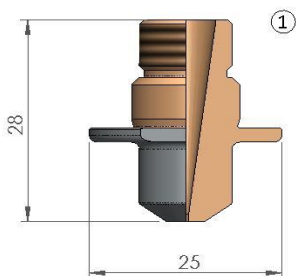

POZ	NUMER REFERENCYJNY	NAZWA
1		MAZAK® NOZZLE PENCIL Ø 0.8 CP
	36143312220	MAZAK® NOZZLE PENCIL Ø 1.2 CP
	36143312230	MAZAK® NOZZLE PENCIL Ø 1.5 CP
	Q6143300060	MAZAK® NOZZLE PENCIL Ø 1.8 CP
	36143312240	MAZAK® NOZZLE PENCIL Ø 2.0 CP
		MAZAK® NOZZLE PENCIL Ø 2.2 CP
	36143312250	MAZAK® NOZZLE PENCIL Ø 2.5 CP
	36143312260	MAZAK® NOZZLE PENCIL Ø 3.0 CP
	36143312270	MAZAK® NOZZLE PENCIL Ø 3.5 CP
	36143312280	MAZAK® NOZZLE PENCIL Ø 4.0 CP
	06143355590	MAZAK® NOZZLE PENCIL Ø 4.5 CP
	06283301030	MAZAK® NOZZLE PENCIL Ø 5.0 CP
	06143355600	MAZAK® NOZZLE PENCIL Ø 5.5 CP

Katalog części zamiennych dla MAZAK®

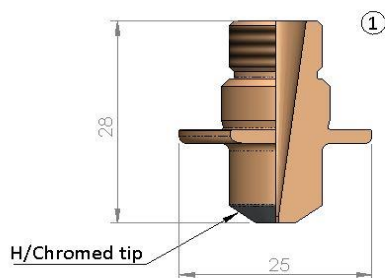

POZ	NUMER REFERENCYJNY	NAZWA
1		MAZAK® NOZZLE PENCIL Ø 0.8 CP
	06283301190	MAZAK® NOZZLE PENCIL Ø 1.0 CP
	36143312220	MAZAK® NOZZLE PENCIL Ø 1.2 CP
	36143312230	MAZAK® NOZZLE PENCIL Ø 1.5 CP
	Q6143300060	MAZAK® NOZZLE PENCIL Ø 1.8 CP
	36143312240	MAZAK® NOZZLE PENCIL Ø 2.0 CP
		MAZAK® NOZZLE PENCIL Ø 2.2 CP
	36143312250	MAZAK® NOZZLE PENCIL Ø 2.5 CP
	36143312260	MAZAK® NOZZLE PENCIL Ø 3.0 CP
	36143312270	MAZAK® NOZZLE PENCIL Ø 3.5 CP
	36143312280	MAZAK® NOZZLE PENCIL Ø 4.0 CP
	06143355590	MAZAK® NOZZLE PENCIL Ø 4.5 CP
	06283301030	MAZAK® NOZZLE PENCIL Ø 5.0 CP
	06143355600	MAZAK® NOZZLE PENCIL Ø 5.5 CP

Katalog części zamiennych dla MAZAK®

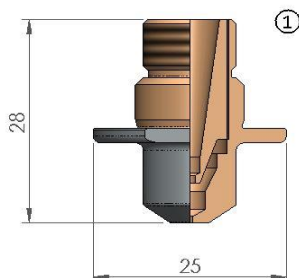

POZ	NUMER REFERENCYJNY	NAZWA
1		MAZAK® DOUBLE NOZZLE PENCIL Ø 0.8 CP
		MAZAK® DOUBLE NOZZLE PENCIL Ø 1.0 CP
	Q6143300080	MAZAK® DOUBLE NOZZLE PENCIL Ø 1.2 CP
	36143312300	MAZAK® DOUBLE NOZZLE PENCIL Ø 1.5 CP
	36143312310	MAZAK® DOUBLE NOZZLE PENCIL Ø 1.8 CP
	36143312311	MAZAK® DOUBLE NOZZLE PENCIL Ø 2.0 CP
		MAZAK® DOUBLE NOZZLE PENCIL Ø 2.2 CP
	36143312320	MAZAK® DOUBLE NOZZLE PENCIL Ø 2.5 CP
	36143312330	MAZAK® DOUBLE NOZZLE PENCIL Ø 3.0 CP
	36143312340	MAZAK® DOUBLE NOZZLE PENCIL Ø 3.5 CP
	36143312350	MAZAK® DOUBLE NOZZLE PENCIL Ø 4.0 CP
	Q6143312360	MAZAK® DOUBLE NOZZLE PENCIL Ø 4.5 CP
	Q6143312370	MAZAK® DOUBLE NOZZLE PENCIL Ø 5.0 CP

Katalog części zamiennych dla MAZAK®

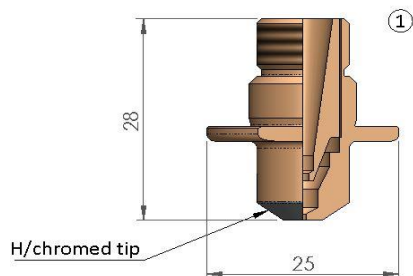

POZ	NUMER REFERENCYJNY	NAZWA
1		MAZAK® DOUBLE NOZZLE PENCIL Ø 0.8 CP
		MAZAK® DOUBLE NOZZLE PENCIL Ø 1.0 CP
	Q6143300080	MAZAK® DOUBLE NOZZLE PENCIL Ø 1.2 CP
	36143312300	MAZAK® DOUBLE NOZZLE PENCIL Ø 1.5 CP
	36143312310	MAZAK® DOUBLE NOZZLE PENCIL Ø 1.8 CP
	36143312311	MAZAK® DOUBLE NOZZLE PENCIL Ø 2.0 CP
		MAZAK® DOUBLE NOZZLE PENCIL Ø 2.2 CP
	36143312320	MAZAK® DOUBLE NOZZLE PENCIL Ø 2.5 CP
	36143312330	MAZAK® DOUBLE NOZZLE PENCIL Ø 3.0 CP
	36143312340	MAZAK® DOUBLE NOZZLE PENCIL Ø 3.5 CP
	36143312350	MAZAK® DOUBLE NOZZLE PENCIL Ø 4.0 CP
	Q6143312360	MAZAK® DOUBLE NOZZLE PENCIL Ø 4.5 CP
	Q6143312370	MAZAK® DOUBLE NOZZLE PENCIL Ø 5.0 CP

Katalog części zamiennych dla MAZAK®

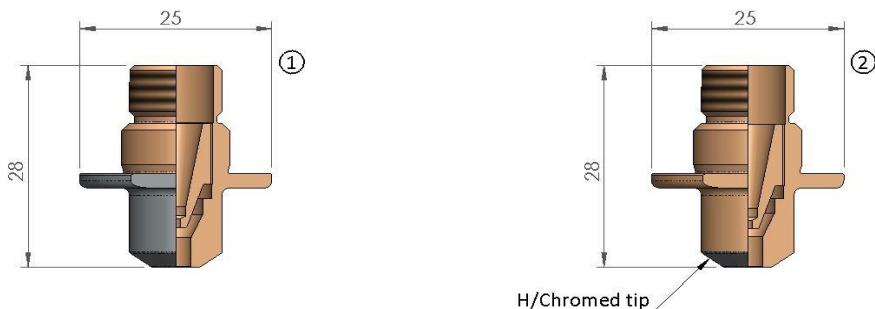

POZ	NUMER REFERENCYJNY	NAZWA
1		MAZAK® DOUBLE NOZZLE PENCIL Ø 4.0-1.2 CP
	06143355360	MAZAK® DOUBLE NOZZLE PENCIL Ø 4.0-1.4 CP
	06143355370	MAZAK® DOUBLE NOZZLE PENCIL Ø 4.0-1.8 CP
	06283301050	MAZAK® DOUBLE NOZZLE PENCIL Ø 4.5-1.2 CP
	06283301200	MAZAK® DOUBLE NOZZLE PENCIL Ø 5.0-1.2 CP
	06283301210	MAZAK® DOUBLE NOZZLE PENCIL Ø 5.5-1.2 CP
	06283301840	MAZAK® DOUBLE NOZZLE PENCIL Ø 5.5-2.0 CP
2		MAZAK® DOUBLE NOZZLE PENCIL Ø 4.0-1.2 CP
	06143355360	MAZAK® DOUBLE NOZZLE PENCIL Ø 4.0-1.4 CP
	06143355370	MAZAK® DOUBLE NOZZLE PENCIL Ø 4.0-1.8 CP
	06283301050	MAZAK® DOUBLE NOZZLE PENCIL Ø 4.5-1.2 CP
	06283301200	MAZAK® DOUBLE NOZZLE PENCIL Ø 5.0-1.2 CP
	06283301210	MAZAK® DOUBLE NOZZLE PENCIL Ø 5.5-1.2 CP
	06283301840	MAZAK® DOUBLE NOZZLE PENCIL Ø 5.5-2.0 CP

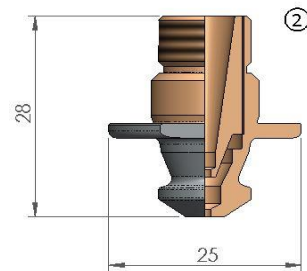
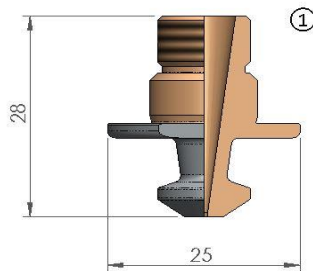
Katalog części zamiennych dla MAZAK®

POZ	NUMER REFERENCYJNY	NAZWA
1	06283301790	MAZAK® NOZZLE PENCIL Ø 1.0/HP CP
	06283301800	MAZAK® NOZZLE PENCIL Ø 1.2HP CP
	06283301810	MAZAK® NOZZLE PENCIL Ø 1.5HP CP
2	06283301820	MAZAK® DOUBLE NOZZLE PENCIL Ø 1.5HP CP

Katalog części zamiennych dla MAZAK®

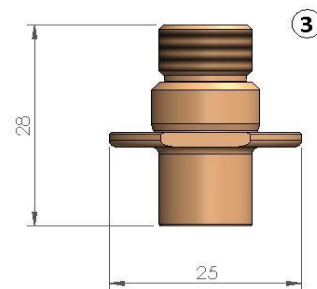
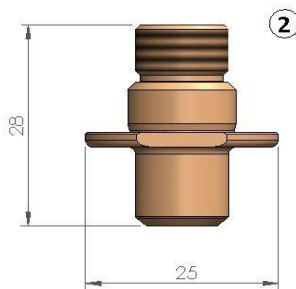
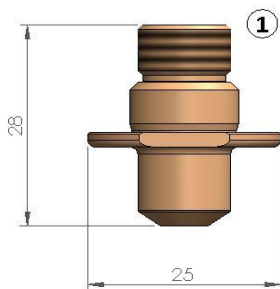

POZ	NUMER REFERENCYJNY	NAZWA
1		MAZAK® DOUBLE NOZZLE Ø 2.5 - SS
		MAZAK® DOUBLE NOZZLE Ø 3.0 - SS
		MAZAK® DOUBLE NOZZLE Ø 4.0 - SS
2		MAZAK® DOUBLE NOZZLE Ø 6.0 - SS
3		MAZAK® DOUBLE NOZZLE Ø 10.0 - SS

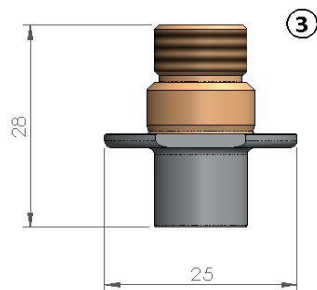
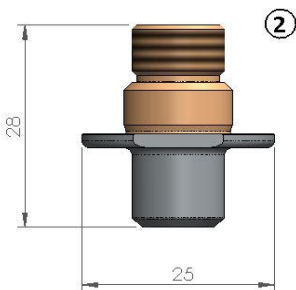
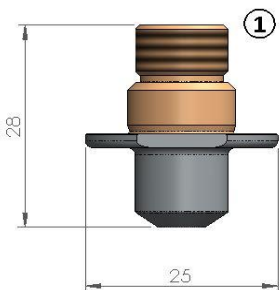

POZ	NUMER REFERENCYJNY	NAZWA
1		MAZAK® DOUBLE NOZZLE Ø 2.5 SPECIAL CP - SS
		MAZAK® DOUBLE NOZZLE Ø 3.0 SPECIAL CP - SS
		MAZAK® DOUBLE NOZZLE Ø 4.0 SPECIAL CP - SS
2		MAZAK® DOUBLE NOZZLE Ø 6.0 SPECIAL CP - SS
3		MAZAK® DOUBLE NOZZLE Ø 10.0 SPECIAL CP - SS

Katalog części zamiennych dla MAZAK®

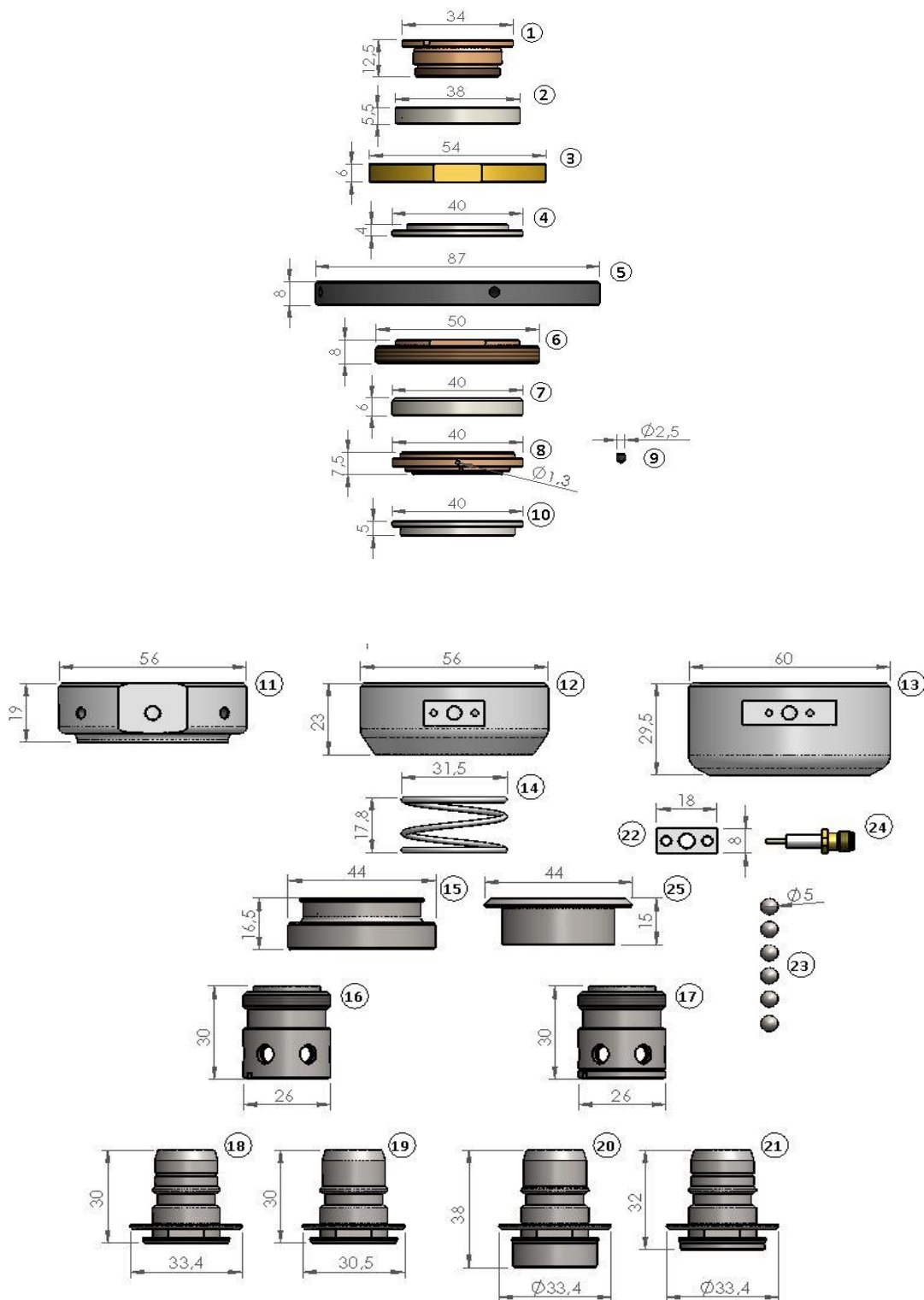

W celu uzyskania informacji o produktach niewymienionych w katalogu, zapraszamy do kontaktu. Numery według producenta zostały umieszczone tylko i wyłącznie w celu ułatwienia prawidłowej specyfikacji towaru.

Katalog części zamiennych dla MAZAK®

POZ	NUMER REFERENCYJNY	NAZWA
1	46143300280	MAZAK® H.G RETAINER NUT
2	46143300270	MAZAK® SPACER PTFE 38 x 5,5
	46143300270	MAZAK® SPACER MACOR 38X5.5
3	46143312100	MAZAK®INSULATING PPS 38X5,5
	46143300320	MAZAK® BRASS NUT 56mm
4	46143300260	MAZAK® SPACER PTFE 40 x 4
	46143300260	MAZAK® SPACER MACOR 40X4
	46143312130	MAZAK®INSULATING PPS 40x4
5	36143300332	MAZAK® H.G. RING ALUMINUM
6	46143300290	MAZAK® H.G RETAINER NUT M50
7	46143304440	MAZAK® SPACER PTFE 40 x 6
	46143304440	MAZAK® SPACER MACOR 40X6
	46143312170	MAZAK®INSULATING PPS 40X6
8	46143307421	MAZAK®H.G. RETAINER NUT
9	46683301180	MAZAK® BOLT
10	46143300240	MAZAK® SPACER PTFE 40 x 5
	46143300240	MAZAK® SPACER MACOR 40X5
	46143312120	MAZAK® INSULATING PPS 40x5
11	36143303242	MAZAK® H.G. BODY
12	36143307980	MAZAK® H.G. ALUMINUM BODY
13	36143310550	MAZAK® H.G. ALUMINUM BODY
14	46143300220	MAZAK® H.G. SPRING
15	46143308000	MAZAK® H.G. RETAINER SPRING STEEL
16	36143304400, 36143304401	MAZAK® H.G. COUPLER
17	36143310531	MAZAK® H.G. COUPLER
18	36143310522	MAZAK® H.G. NOZZLE HOLDER LARGE
19	36143304420	MAZAK® H.G. NOZZLE HOLDER
20	36143310740	MAZAK® H.G. NOZZLE HOLDER LONG
21	36143310522	MAZAK® H.G. NOZZLE HOLDER
22	46143308170	MAZAK® H.G. SPACER FOR CONNECTOR ALUMINUM
23	46143300230	MAZAK® H.G. BALL KIT REPLACEMENT 6pcs
24	46143308190	MAZAK® H.G CONNECTOR
25	36143310541 - 36143310542	MAZAK® H.G. RETAINER STEEL

Katalog części zamiennych dla MAZAK®

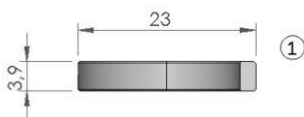

POZ	NUMER REFERENCYJNY	NAZWA
1	46143312180	MAZAK® INSULATING 23X4



POZ	NUMER REFERENCYJNY	NAZWA
1	46143308290	MAZAK® DOWNSIDE CABLE OF PREAMP BUILT-IN TYPE

OPTYKA

POZ	NUMER REFERENCYJNY	OPIS
1	Z50ZZ005160/ Z50ZZ011780	PLANO CONVEX LENS Diam. 50.8 mm 2.0" Thick. 9.65 mm Fl. 5.0"
2	Z50ZZ011770/ Z50ZZ013470	PLANO CONVEX LENS Diam. 50.8 mm 2.0" Thick. 9.65 mm Fl. 7.5"
3		ZnSe MENISCUS LENS Diam. 50.8 mm 2.0" Thick. 9.65 mm Fl. 5.0"
4		ZnSe MENISCUS LENS Diam. 50.8 mm 2.0" Thick. 9.65 mm Fl. 7.5"
5	Z50SA015350	PROTECTIVE WINDOWS 42 x 9mm

SMARY OLEJE I FILTRY