

Katalog części zamiennych dla PRECITEC®

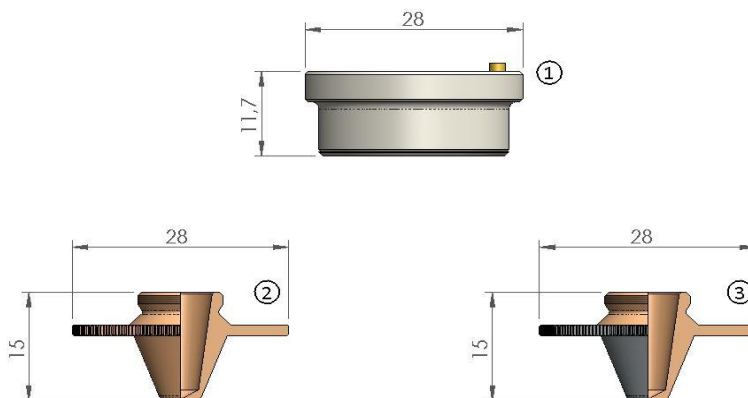

POZ	NUMER REFERENCYJNY	NAZWA
1	281330, P0571-260-00001, 6930281330	PRECITEC® ORIGINAL NOZZLE HOLDER KT B2"
	P0571-260-00001	PRECITEC® NOZZLE HOLDER KT B2"
	P0571-1051-00001, 6930281333	PRECITEC® ORIGINAL NOZZLE HOLDER KT B2" CON
	P0571-1051-00001, 6930281333	PRECITEC® NOZZLE HOLDER KT B2" CON
2	281590-P0591-569-00008	PRECITEC® NOZZLE Ø 0.8
	281331-P0591-561-00010	PRECITEC® NOZZLE Ø 1.0
	281351-P0591-562-00012	PRECITEC® NOZZLE Ø 1.2
	281352-P0591-563-00015	PRECITEC® NOZZLE Ø 1.5
		PRECITEC® NOZZLE Ø 1.7
	281353-P0591-564-00018	PRECITEC® NOZZLE Ø 1.8
	281354-P0591-565-00020	PRECITEC® NOZZLE Ø 2.0
		PRECITEC® NOZZLE Ø 2.3
	281591-P0591-566-00025	PRECITEC® NOZZLE Ø 2.5
		PRECITEC® NOZZLE Ø 2.7
	PRECITEC® NOZZLE Ø 3.0	
3	281590-P0591-569-00008	PRECITEC® NOZZLE Ø 0.8 CP
	281331-P0591-561-00010	PRECITEC® NOZZLE Ø 1.0 CP
	281351-P0591-562-00012	PRECITEC® NOZZLE Ø 1.2 CP
	281352-P0591-563-00015	PRECITEC® NOZZLE Ø 1.5 CP
		PRECITEC® NOZZLE Ø 1.7 CP
	281353-P0591-564-00018	PRECITEC® NOZZLE Ø 1.8 CP
	281354-P0591-565-00020	PRECITEC® NOZZLE Ø 2.0 CP
		PRECITEC® NOZZLE Ø 2.3 CP
	281591-P0591-566-00025	PRECITEC® NOZZLE Ø 2.5 CP
		PRECITEC® NOZZLE Ø 2.7 CP
	PRECITEC® NOZZLE Ø 3.0 CP	

Katalog części zamiennych dla PRECITEC®



POZ	NUMER REFERENCYJNY	NAZWA
1		PRECITEC® NOZZLE Ø 0.8 HD
	281548-P0591-571-00010-29100233	PRECITEC® NOZZLE Ø 1.0 HD
	281549-P0591-572-00012-29100234	PRECITEC® NOZZLE Ø 1.2 HD
		PRECITEC® NOZZLE Ø 1.4 HD
	P0591-573-00015-281463-29100235	PRECITEC® NOZZLE Ø 1.5 HD
	P0591-574-00018-29100236	PRECITEC® NOZZLE Ø 1.8 HD
	10.03.11.09.011-281550-P0591-575-00020-29100237	PRECITEC® NOZZLE Ø 2.0 HD
		PRECITEC® NOZZLE Ø 2.3 HD
	10.03.11.09.012-281551-P0591-576-00025-29100239	PRECITEC® NOZZLE Ø 2.5 HD
		PRECITEC® NOZZLE Ø 2.75 HD
	P0591-577-00030 10.03.11.09.013-2	PRECITEC® NOZZLE Ø 3.0 HD
		PRECITEC® NOZZLE Ø 3.2 HD
	10.03.11.09.014-29100243	PRECITEC® NOZZLE Ø 3.5 HD
		PRECITEC® NOZZLE Ø 4.0 HD
		PRECITEC® NOZZLE Ø 4.5 HD
		PRECITEC® NOZZLE Ø 5.0 HD
2		PRECITEC® NOZZLE Ø 0.8 HD CP
	281548-P0591-571-00010	PRECITEC® NOZZLE Ø 1.0 HD CP
	281549-P0591-572-00012	PRECITEC® NOZZLE Ø 1.2 HD CP
		PRECITEC® NOZZLE Ø 1.4 HD CP
	281463-P0591-573-00015	PRECITEC® NOZZLE Ø 1.5 HD CP
	P0591-574-00018	PRECITEC® NOZZLE Ø 1.8 HD CP
	281550-P0591-575-00020	PRECITEC® NOZZLE Ø 2.0 HD CP
		PRECITEC® NOZZLE Ø 2.3 HD CP
	281551-P0591-576-00025	PRECITEC® NOZZLE Ø 2.5 HD CP
		PRECITEC® NOZZLE Ø 2.75 HD CP
		PRECITEC® NOZZLE Ø 3.0 HD CP
		PRECITEC® NOZZLE Ø 3.2 HD CP
		PRECITEC® NOZZLE Ø 3.5 HD CP
		PRECITEC® NOZZLE Ø 4.0 HD CP
		PRECITEC® NOZZLE Ø 4.5 HD CP
		PRECITEC® NOZZLE Ø 5.0 HD CP

Katalog części zamiennych dla PRECITEC®

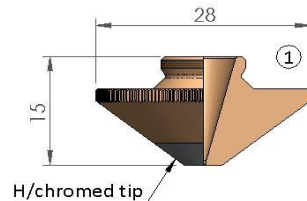

POZ	NUMER REFERENCYJNY	NAZWA
1		PRECITEC® NOZZLE Ø 0.8 HD CP
		PRECITEC® NOZZLE Ø 1.0 HD CP
		PRECITEC® NOZZLE Ø 1.2 HD CP
		PRECITEC® NOZZLE Ø 1.4 HD CP
		PRECITEC® NOZZLE Ø 1.5 HD CP
		PRECITEC® NOZZLE Ø 1.8 HD CP
		PRECITEC® NOZZLE Ø 2.0 HD CP
		PRECITEC® NOZZLE Ø 2.3 HD CP
		PRECITEC® NOZZLE Ø 2.5 HD CP
		PRECITEC® NOZZLE Ø 2.75 HD CP
		PRECITEC® NOZZLE Ø 3.0 HD CP
		PRECITEC® NOZZLE Ø 3.2 HD CP
		PRECITEC® NOZZLE Ø 3.5 HD CP
		PRECITEC® NOZZLE Ø 4.0 HD CP
		PRECITEC® NOZZLE Ø 4.5 HD CP
	PRECITEC® NOZZLE Ø 5.0 HD CP	

Katalog części zamiennych dla PRECITEC®

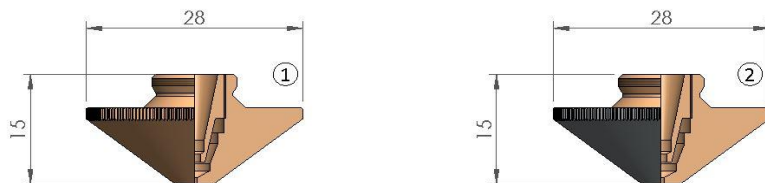

POZ	NUMER REFERENCYJNY	NAZWA
1		PRECITEC® DOUBLE NOZZLE Ø 0.8
	P0591-002-00010	PRECITEC® DOUBLE NOZZLE Ø 1.0
	P0591-002-00012	PRECITEC® DOUBLE NOZZLE Ø 1.2
		PRECITEC® DOUBLE NOZZLE Ø 1.4
	P0591-002-00015	PRECITEC® DOUBLE NOZZLE Ø 1.5
	10.03.11.09.031/P0591-002-00018	PRECITEC® DOUBLE NOZZLE Ø 1.8
	P0591-002-00020	PRECITEC® DOUBLE NOZZLE Ø 2.0
	P0591-002-00023	PRECITEC® DOUBLE NOZZLE Ø 2.3
	P0591-002-00025	PRECITEC® DOUBLE NOZZLE Ø 2.5
		PRECITEC® DOUBLE NOZZLE Ø 2.7
	P0591-002-00030	PRECITEC® DOUBLE NOZZLE Ø 3.0
	P0591-002-00035-29100384	PRECITEC® DOUBLE NOZZLE Ø 3.5
	P0591-002-00040	PRECITEC® DOUBLE NOZZLE Ø 4.0
		PRECITEC® DOUBLE NOZZLE Ø 4.5
	10.03.11.09.029	PRECITEC® DOUBLE NOZZLE Ø 5.0
2		PRECITEC® DOUBLE NOZZLE Ø 0.8 CP
		PRECITEC® DOUBLE NOZZLE Ø 1.0 CP
		PRECITEC® DOUBLE NOZZLE Ø 1.2 CP
		PRECITEC® DOUBLE NOZZLE Ø 1.4 CP
		PRECITEC® DOUBLE NOZZLE Ø 1.5 CP
		PRECITEC® DOUBLE NOZZLE Ø 1.8 CP
		PRECITEC® DOUBLE NOZZLE Ø 2.0 CP
		PRECITEC® DOUBLE NOZZLE Ø 2.3 CP
		PRECITEC® DOUBLE NOZZLE Ø 2.5 CP
		PRECITEC® DOUBLE NOZZLE Ø 2.7 CP
		PRECITEC® DOUBLE NOZZLE Ø 3.0 CP
		PRECITEC® DOUBLE NOZZLE Ø 3.5 CP
		PRECITEC® DOUBLE NOZZLE Ø 4.0 CP
		PRECITEC® DOUBLE NOZZLE Ø 4.5 CP
		PRECITEC® DOUBLE NOZZLE Ø 5.0 CP

Katalog części zamiennych dla PRECITEC®

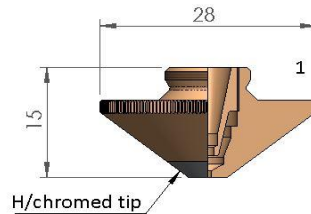

POZ	NUMER REFERENCYJNY	NAZWA
1		PRECITEC® DOUBLE NOZZLE Ø 0.8 CP
		PRECITEC® DOUBLE NOZZLE Ø 1.0 CP
		PRECITEC® DOUBLE NOZZLE Ø 1.2 CP
		PRECITEC® DOUBLE NOZZLE Ø 1.4 CP
		PRECITEC® DOUBLE NOZZLE Ø 1.5 CP
		PRECITEC® DOUBLE NOZZLE Ø 1.8 CP
		PRECITEC® DOUBLE NOZZLE Ø 2.0 CP
		PRECITEC® DOUBLE NOZZLE Ø 2.3 CP
		PRECITEC® DOUBLE NOZZLE Ø 2.5 CP
		PRECITEC® DOUBLE NOZZLE Ø 2.7 CP
		PRECITEC® DOUBLE NOZZLE Ø 3.0 CP
		PRECITEC® DOUBLE NOZZLE Ø 3.5 CP
		PRECITEC® DOUBLE NOZZLE Ø 4.0 CP
		PRECITEC® DOUBLE NOZZLE Ø 4.5 CP
		PRECITEC® DOUBLE NOZZLE Ø 5.0 CP

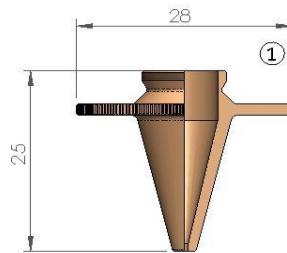
Katalog części zamiennych dla PRECITEC®

POZ	NUMER REFERENCYJNY	NAZWA
1		PRECITEC® NOZZLE LONG Ø 1.0
		PRECITEC® NOZZLE LONG Ø 1.5
		PRECITEC® NOZZLE LONG Ø 1.8
		PRECITEC® NOZZLE LONG Ø 2.0

Katalog części zamiennych dla PRECITEC®

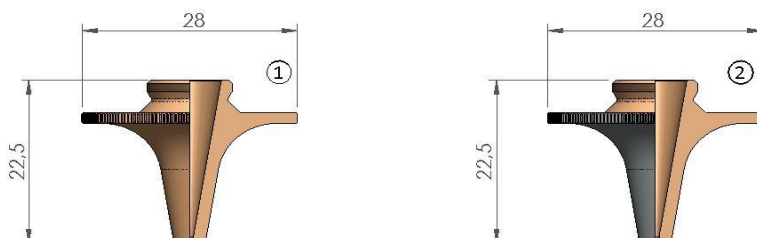

POZ	NUMER REFERENCYJNY	NAZWA
1	P0578-0411-00010	PRECITEC® NOZZLE RADIUS LONG Ø 1.0
	P0578-0412-00012	PRECITEC® NOZZLE RADIUS LONG Ø 1.2
	P0578-0413-00015 / 6930300039	PRECITEC® NOZZLE RADIUS LONG Ø 1.5
	P0578-0414-00018	PRECITEC® NOZZLE RADIUS LONG Ø 1.8
	P0578-0415-00020 / 6930300040	PRECITEC® NOZZLE RADIUS LONG Ø 2.0
	P0578-0417-00025	PRECITEC® NOZZLE RADIUS LONG Ø 2.5
2		PRECITEC® NOZZLE RADIUS LONG Ø 1.0 CP
		PRECITEC® NOZZLE RADIUS LONG Ø 1.2 CP
		PRECITEC® NOZZLE RADIUS LONG Ø 1.5 CP
		PRECITEC® NOZZLE RADIUS LONG Ø 1.8 CP
		PRECITEC® NOZZLE RADIUS LONG Ø 2.0 CP
		PRECITEC® NOZZLE RADIUS LONG Ø 2.5 CP

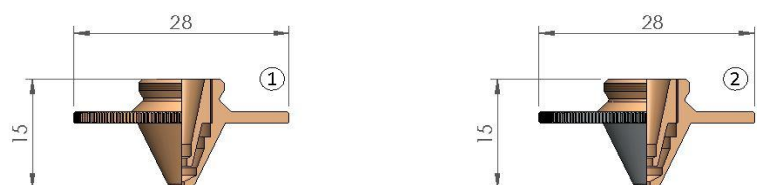

POZ	NUMER REFERENCYJNY	NAZWA
1	6930250001	PRECITEC® DOUBLE NOZZLE Ø 0.8
	6930250002	PRECITEC® DOUBLE NOZZLE Ø 1.0
	6930250003	PRECITEC® DOUBLE NOZZLE Ø 1.2
	6930250004	PRECITEC® DOUBLE NOZZLE Ø 1.5
		PRECITEC® DOUBLE NOZZLE Ø 1.8
2		PRECITEC® DOUBLE NOZZLE Ø 0.8 CP
		PRECITEC® DOUBLE NOZZLE Ø 1.0 CP
		PRECITEC® DOUBLE NOZZLE Ø 1.2 CP
		PRECITEC® DOUBLE NOZZLE Ø 1.5 CP
		PRECITEC® DOUBLE NOZZLE Ø 1.8 CP

Katalog części zamiennych dla PRECITEC®

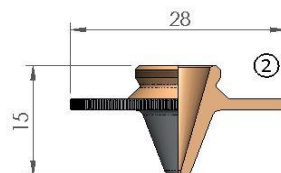
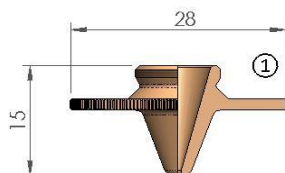

POZ	NUMER REFERENCYJNY	NAZWA
1		PRECITEC® NOZZLE Ø 0.8
		PRECITEC® NOZZLE Ø 1.0
		PRECITEC® NOZZLE Ø 1.2
		PRECITEC® NOZZLE Ø 1.5
2		PRECITEC® NOZZLE Ø 0.8 CP
		PRECITEC® NOZZLE Ø 1.0 CP
		PRECITEC® NOZZLE Ø 1.2 CP
		PRECITEC® NOZZLE Ø 1.5 CP

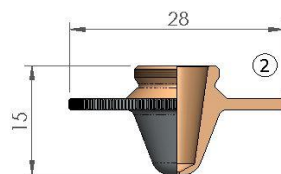
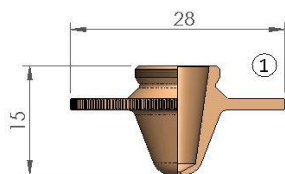

POZ	NUMER REFERENCYJNY	NAZWA
1		PRECITEC® NOZZLE Ø 0.8
		PRECITEC® NOZZLE Ø 1.0
		PRECITEC® NOZZLE Ø 1.2
	P0591-1049-00015	PRECITEC® NOZZLE Ø 1.5
	P0591-1050-00018	PRECITEC® NOZZLE Ø 1.8
		PRECITEC® NOZZLE Ø 2.0
2		PRECITEC® NOZZLE Ø 0.8 CP
		PRECITEC® NOZZLE Ø 1.0 CP
		PRECITEC® NOZZLE Ø 1.2 CP
		PRECITEC® NOZZLE Ø 1.5 CP
		PRECITEC® NOZZLE Ø 1.8 CP
		PRECITEC® NOZZLE Ø 2.0 CP

Katalog części zamiennych dla PRECITEC®

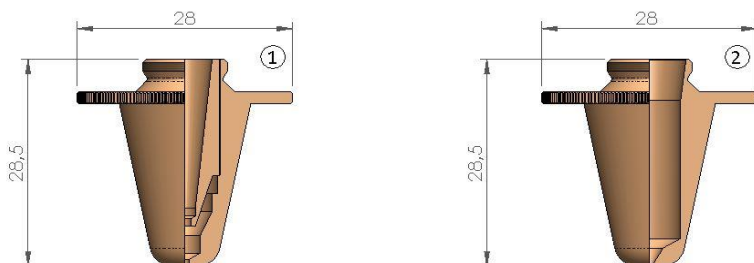

POZ	NUMER REFERENCYJNY	NAZWA
1		PRECITEC® DOUBLE NOZZLE Ø 1.0
		PRECITEC® DOUBLE NOZZLE Ø 1.2
		PRECITEC® DOUBLE NOZZLE Ø 1.5
		PRECITEC® DOUBLE NOZZLE Ø 1.8
		PRECITEC® DOUBLE NOZZLE Ø 2.0
		PRECITEC® DOUBLE NOZZLE Ø 2.3
		PRECITEC® DOUBLE NOZZLE Ø 2.5
		PRECITEC® DOUBLE NOZZLE Ø 3.0
		PRECITEC® DOUBLE NOZZLE Ø 3.5
2	P0573-563-00010	PRECITEC® NOZZLE Ø 1.0
	P0573-563-00012	PRECITEC® NOZZLE Ø 1.2
	P0573-563-00015	PRECITEC® NOZZLE Ø 1.5
		PRECITEC® NOZZLE Ø 1.8
	P0573-563-00020	PRECITEC® NOZZLE Ø 2.0
	P0573-563-00025	PRECITEC® NOZZLE Ø 2.5
	PRECITEC® NOZZLE Ø 3.0	

Katalog części zamiennych dla PRECITEC®

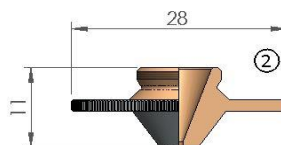
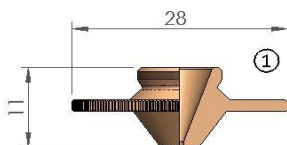

POZ	NUMER REFERENCYJNY	NAZWA
1		PRECITEC® NOZZLE Ø 1.0 HD
		PRECITEC® NOZZLE Ø 1.2 HD
		PRECITEC® NOZZLE Ø 1.5 HD
		PRECITEC® NOZZLE Ø 2.0 HD
		PRECITEC® NOZZLE Ø 2.5 HD
		PRECITEC® NOZZLE Ø 3.0 HD
		PRECITEC® NOZZLE Ø 3.5 HD
		PRECITEC® NOZZLE Ø 4.0 HD
		PRECITEC® NOZZLE Ø 4.5 HD
		PRECITEC® NOZZLE Ø 5.0 HD
2		PRECITEC® NOZZLE Ø 1.0 HD CP
		PRECITEC® NOZZLE Ø 1.2 HD CP
		PRECITEC® NOZZLE Ø 1.5 HD CP
		PRECITEC® NOZZLE Ø 2.0 HD
		PRECITEC® NOZZLE Ø 2.5 HD CP
		PRECITEC® NOZZLE Ø 3.0 HD CP
		PRECITEC® NOZZLE Ø 3.5 HD CP
		PRECITEC® NOZZLE Ø 4.0 HD CP
		PRECITEC® NOZZLE Ø 4.0 HD CP
		PRECITEC® NOZZLE Ø 5.0 HD CP

Katalog części zamiennych dla PRECITEC®



POZ	NUMER REFERENCYJNY	NAZWA
1		PRECITEC® NOZZLE Ø 1.5 HD
		PRECITEC® NOZZLE Ø 2.0 HD
		PRECITEC® NOZZLE Ø 2.5 HD
2		PRECITEC® NOZZLE Ø 1.5 HD CP
		PRECITEC® NOZZLE Ø 2.0 HD CP
		PRECITEC® NOZZLE Ø 2.5 HD CP

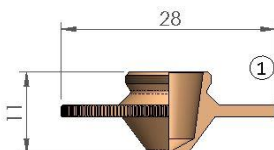

POZ	NUMER REFERENCYJNY	NAZWA
1	281340/P0571-281-00010	PRECITEC® NOZZLE Ø 1.0
	281341/P0571-282-00012	PRECITEC® NOZZLE Ø 1.2
	281342/P0571-283-00015	PRECITEC® NOZZLE Ø 1.5
	281342/P0571-284-00018	PRECITEC® NOZZLE Ø 1.8
	281343/P0571-285-00020	PRECITEC® NOZZLE Ø 2.0
	281344/P0571-286-00025	PRECITEC® NOZZLE Ø 2.5

Katalog części zamiennych dla PRECITEC®

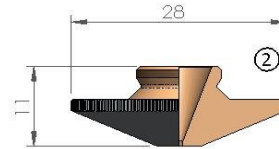
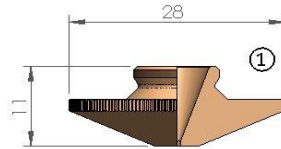

POZ	NUMER REFERENCYJNY	NAZWA
1	281559/P0571-291-00010	PRECITEC® NOZZLE Ø 1.0
	P0571-292-00012	PRECITEC® NOZZLE Ø 1.2
	281570/P0571-293-00015	PRECITEC® NOZZLE Ø 1.5
		PRECITEC® NOZZLE Ø 1.8
	281571/P0571-295-00020	PRECITEC® NOZZLE Ø 2.0
	281572/P0571-297-00025	PRECITEC® NOZZLE Ø 2.5
		PRECITEC® NOZZLE Ø 3.0
2		PRECITEC® NOZZLE Ø 1.0 CP
		PRECITEC® NOZZLE Ø 1.2 CP
		PRECITEC® NOZZLE Ø 1.5 CP
		PRECITEC® NOZZLE Ø 1.8 CP
		PRECITEC® NOZZLE Ø 2.0 CP
		PRECITEC® NOZZLE Ø 2.5 CP
	PRECITEC® NOZZLE Ø 3.0 CP	

Katalog części zamiennych dla PRECITEC®

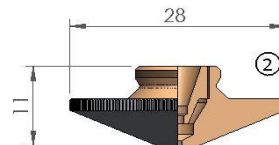
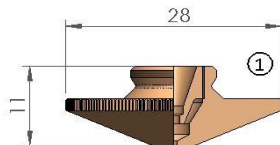

POZ	NUMER REFERENCYJNY	NAZWA
1		PRECITEC® DOUBLE NOZZLE Ø 1.0
		PRECITEC® DOUBLE NOZZLE Ø 1.2
		PRECITEC® DOUBLE NOZZLE Ø 1.4
		PRECITEC® DOUBLE NOZZLE Ø 1.5
		PRECITEC® DOUBLE NOZZLE Ø 1.8
		PRECITEC® DOUBLE NOZZLE Ø 2.0
		PRECITEC® DOUBLE NOZZLE Ø 2.5
		PRECITEC® DOUBLE NOZZLE Ø 3.0
		PRECITEC® DOUBLE NOZZLE Ø 3.5
2		PRECITEC® DOUBLE NOZZLE Ø 1.0 CP
		PRECITEC® DOUBLE NOZZLE Ø 1.2 CP
		PRECITEC® DOUBLE NOZZLE Ø 1.4 CP
		PRECITEC® DOUBLE NOZZLE Ø 1.5 CP
		PRECITEC® DOUBLE NOZZLE Ø 1.8 CP
		PRECITEC® DOUBLE NOZZLE Ø 2.0 CP
		PRECITEC® DOUBLE NOZZLE Ø 2.5 CP
		PRECITEC® DOUBLE NOZZLE Ø 3.0 CP
		PRECITEC® DOUBLE NOZZLE Ø 3.5 CP

Katalog części zamiennych dla PRECITEC®

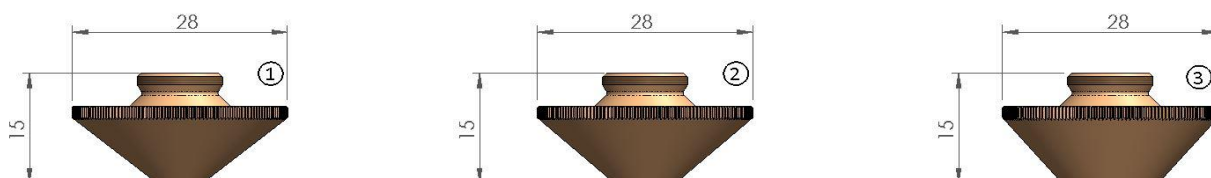

POZ	NUMER REFERENCYJNY	NAZWA
1		PRECITEC® DOUBLE NOZZLE Ø 2.5 - SS
		PRECITEC® DOUBLE NOZZLE Ø 3.0 - SS
		PRECITEC® DOUBLE NOZZLE Ø 4.0 - SS
2		PRECITEC® DOUBLE NOZZLE Ø 6.0 - SS
3		PRECITEC® DOUBLE NOZZLE Ø 10.0 - SS

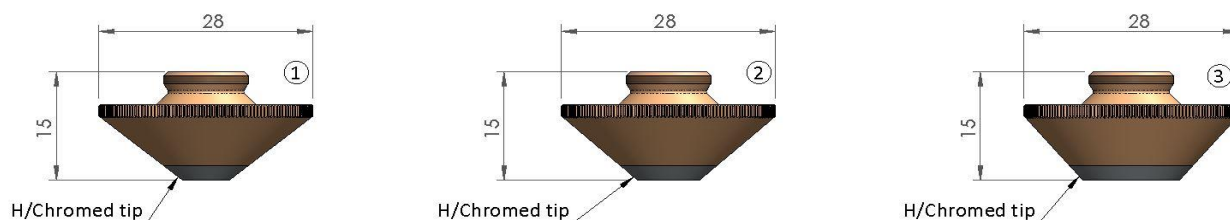

POZ	NUMER REFERENCYJNY	NAZWA
1		PRECITEC® DOUBLE NOZZLE Ø 2.5 CP - SS
		PRECITEC® DOUBLE NOZZLE Ø 3.0 CP - SS
		PRECITEC® DOUBLE NOZZLE Ø 4.0 CP - SS
2		PRECITEC® DOUBLE NOZZLE Ø 6.0 CP - SS
3		PRECITEC® DOUBLE NOZZLE Ø 10.0 CP - SS

Katalog części zamiennych dla PRECITEC®

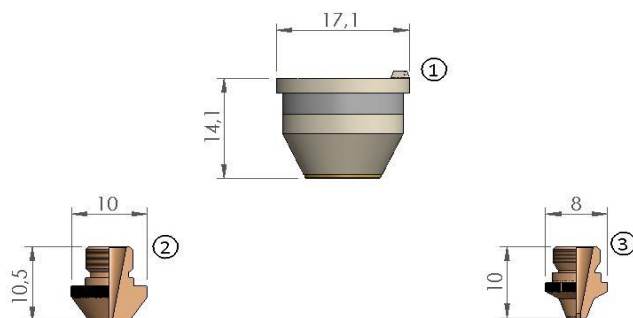

POZ	NUMER REFERENCYJNY	NAZWA
1	280408-P0494-752-00001-092405	PRECITEC® ORIGINAL NOZZLE HOLDER KT M1,5" KN
2		PRECITEC® NOZZLE Ø 0.8
	280551-P0494-853-00010	PRECITEC® NOZZLE Ø 1.0
	280552-P0494-854-00012	PRECITEC® NOZZLE Ø 1.2
	280553-P0494-855-00015	PRECITEC® NOZZLE Ø 1.5
	280554-P0494-856-00017	PRECITEC® NOZZLE Ø 1.7
	280555-P0494-857-00020	PRECITEC® NOZZLE Ø 2.0
		PRECITEC® NOZZLE Ø 2.3
		PRECITEC® NOZZLE Ø 2.5
3	280943-P0494-787-00010	PRECITEC® NOZZLE Ø 1.0
	280942-P0494-788-00012	PRECITEC® NOZZLE Ø 1.2
	280941-P0494-789-00015	PRECITEC® NOZZLE Ø 1.5
		PRECITEC® NOZZLE Ø 1.8
		PRECITEC® NOZZLE Ø 2.0

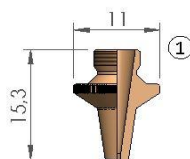

POZ	NUMER REFERENCYJNY	NAZWA
1		PRECITEC® NOZZLE Ø 1.0
	P0787-483-00012	PRECITEC® NOZZLE Ø 1.2
	P0787-483-00015	PRECITEC® NOZZLE Ø 1.5
		PRECITEC® NOZZLE Ø 1.7
	P0787-1001-00020	PRECITEC® NOZZLE Ø 2.0
	PRECITEC® NOZZLE Ø 2.5	

Katalog części zamiennych dla PRECITEC®

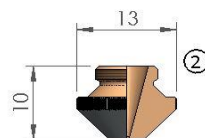
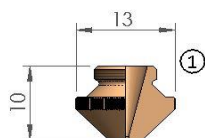

POZ	NUMER REFERENCYJNY	NAZWA
1	280013, P0492-441-00008, W222	PRECITEC® NOZZLE Ø 0.8
	280014, P0492-442-00010, W223	PRECITEC® NOZZLE Ø 1.0
	280015, P0492-443-00012, W228	PRECITEC® NOZZLE Ø 1.2
	280016, P0492-444-00015, W224	PRECITEC® NOZZLE Ø 1.5
	P0492-447-00018	PRECITEC® NOZZLE Ø 1.8
	280937, P0492-445-00020, W225	PRECITEC® NOZZLE Ø 2.0
	P0492-448-00023	PRECITEC® NOZZLE Ø 2.3
	281791, P0492-446-00025, W226	PRECITEC® NOZZLE Ø 2,5
	PRECITEC® NOZZLE Ø 3.0	
2	280013, P0492-441-00008, W222	PRECITEC® NOZZLE Ø 0.8 CP
	280014, P0492-442-00010, W223	PRECITEC® NOZZLE Ø 1.0 CP
	280015, P0492-443-00012, W228	PRECITEC® NOZZLE Ø 1.2 CP
	280016, P0492-444-00015, W224	PRECITEC® NOZZLE Ø 1.5 CP
	P0492-447-00018	PRECITEC® NOZZLE Ø 1.8 CP
	280937, P0492-445-00020, W225	PRECITEC® NOZZLE Ø 2.0 CP
	P0492-448-00023	PRECITEC® NOZZLE Ø 2.3 CP
	281791, P0492-446-00025, W226	PRECITEC® NOZZLE Ø 2,5 CP
	PRECITEC® NOZZLE Ø 3.0 CP	

Katalog części zamiennych dla PRECITEC®



POZ	NUMER REFERENCYJNY	NAZWA
1	281813, P0589-424-00008	PRECITEC® NOZZLE Ø 0.8
	281789, P0589-426-00010	PRECITEC® NOZZLE Ø 1.0
	281561, 778550	PRECITEC® NOZZLE Ø 1.2
	281814, 149957	PRECITEC® NOZZLE Ø 1.5
	P0589-428-00020	PRECITEC® NOZZLE Ø 2.0
2	281813, P0589-424-00008	PRECITEC® NOZZLE Ø 0.8 CP
	281789, P0589-426-00010	PRECITEC® NOZZLE Ø 1.0 CP
	281561, 778550	PRECITEC® NOZZLE Ø 1.2 CP
	281814, 149957	PRECITEC® NOZZLE Ø 1.5 CP
	P0589-428-00020	PRECITEC® NOZZLE Ø 2.0 CP

OPTYKA

POZ	NUMER REFERENCYJNY	OPIS
1	P0595-58601 (P0595-61551)	Szkoło ochronne Ø 37 x 7 mm
2	P0795-1201-00002	Szkoło ochronne Ø 30 x 5 mm
3	P0589-360-00002 (ex P0589-360-00001)	Szkoło ochronne Ø 22.35 x 4 mm