

Katalog części zamiennych dla PRIMA INDUSTRIE®

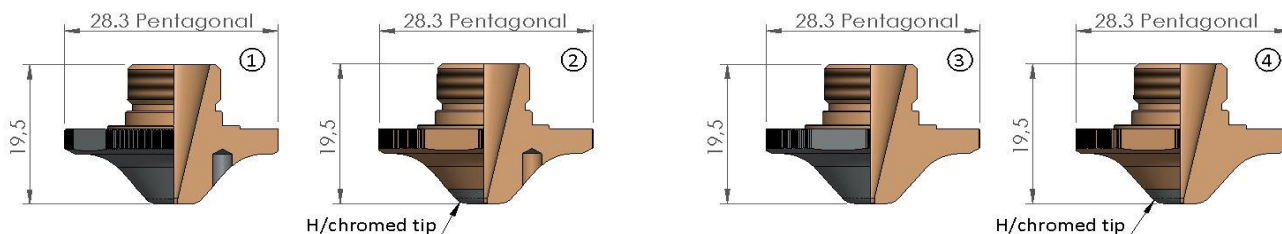

POZ	NUMER REFERENCYJNY	NAZWA
1	LW6.1G.660	PRIMA I.® NOZZLE PENT Ø 0.8 CP
	LW6.1G.661	PRIMA I.® NOZZLE PENT Ø 1.0 CP
	LW6.1G.662	PRIMA I.® NOZZLE PENT Ø 1.25 CP
	LW6.1G.663	PRIMA I.® NOZZLE PENT Ø 1.5 CP
	LW6.1G.664	PRIMA I.® NOZZLE PENT Ø 1.75 CP
	LW6.1G.665	PRIMA I.® NOZZLE PENT Ø 2.0 CP
	LW6.1G.667	PRIMA I.® NOZZLE PENT Ø 2.5 CP
	LW6.1G.669	PRIMA I.® NOZZLE PENT Ø 3.0 CP
	LW6.1G.670	PRIMA I.® NOZZLE PENT Ø 3.5 CP
	LW6.1G.666	PRIMA I.® NOZZLE PENT Ø 2.25 CP
	LW6.1G.668	PRIMA I.® NOZZLE PENT Ø 2.75 CP
	2	LW6.1G.660
LW6.1G.661		PRIMA I.® NOZZLE PENT Ø 1.0 CP
LW6.1G.662		PRIMA I.® NOZZLE PENT Ø 1.25 CP
LW6.1G.663		PRIMA I.® NOZZLE PENT Ø 1.5 CP
LW6.1G.664		PRIMA I.® NOZZLE PENT Ø 1.75 CP
LW6.1G.665		PRIMA I.® NOZZLE PENT Ø 2.0 CP
LW6.1G.667		PRIMA I.® NOZZLE PENT Ø 2.5 CP
LW6.1G.669		PRIMA I.® NOZZLE PENT Ø 3.0 CP
LW6.1G.670		PRIMA I.® NOZZLE PENT Ø 3.5 CP
LW6.1G.666		PRIMA I.® NOZZLE PENT Ø 2.25 CP
LW6.1G.668		PRIMA I.® NOZZLE PENT Ø 2.75 CP
3		LW6.1G.103
	LW6.1G.105	PRIMA I.® NOZZLE PENT Ø 2.0 CP
	LW6.1G.107	PRIMA I.® NOZZLE PENT Ø 2.5 CP
	LW6.1G.109	PRIMA I.® NOZZLE PENT Ø 3.0 CP
4	LW6.1G.103	PRIMA I.® NOZZLE PENT Ø 1.5 CP
	LW6.1G.105	PRIMA I.® NOZZLE PENT Ø 2.0 CP
	LW6.1G.107	PRIMA I.® NOZZLE PENT Ø 2.5 CP
	LW6.1G.109	PRIMA I.® NOZZLE PENT Ø 3.0 CP

Katalog części zamiennych dla PRIMA INDUSTRIE®

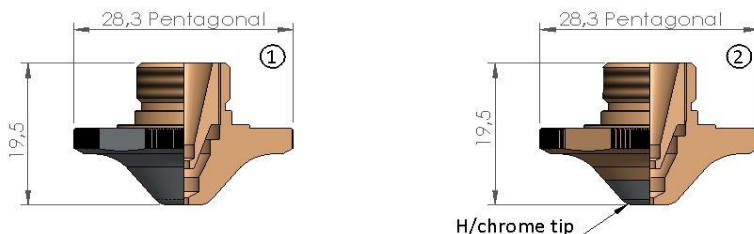

POZ	NUMER REFERENCYJNY	NAZWA
1	LW6.1G.302	PRIMA I.® DOUBLE NOZZLE PENT Ø 1.25 CP
	LW6.1G.303	PRIMA I.® DOUBLE NOZZLE PENT Ø 1.5 CP
	LW6.1G.304	PRIMA I.® DOUBLE NOZZLE PENT Ø 1.75 CP
	LW6.1G.305	PRIMA I.® DOUBLE NOZZLE PENT Ø 2.0 CP
	LW6.1G.307	PRIMA I.® DOUBLE NOZZLE PENT Ø 2.5 CP
	LW6.1E.204	PRIMA I.® DOUBLE NOZZLE PENT Ø 2.5 CP
	LW6.1G.309	PRIMA I.® DOUBLE NOZZLE PENT Ø 3.0 CP
	LW6.1E.206	PRIMA I.® DOUBLE NOZZLE PENT Ø 3.0 CP
	LW6.1E.207	PRIMA I.® DOUBLE NOZZLE PENT Ø 3.5 CP
2	LW6.1G.302	PRIMA I.® DOUBLE NOZZLE PENT Ø 1.25 CP
	LW6.1G.303	PRIMA I.® DOUBLE NOZZLE PENT Ø 1.5 CP
	LW6.1G.304	PRIMA I.® DOUBLE NOZZLE PENT Ø 1.75 CP
	LW6.1G.305	PRIMA I.® DOUBLE NOZZLE PENT Ø 2.0 CP
	LW6.1G.307	PRIMA I.® DOUBLE NOZZLE PENT Ø 2.5 CP
	LW6.1E.204	PRIMA I.® DOUBLE NOZZLE PENT Ø 2.5 CP
	LW6.1G.309	PRIMA I.® DOUBLE NOZZLE PENT Ø 3.0 CP
	LW6.1E.206	PRIMA I.® DOUBLE NOZZLE PENT Ø 3.0 CP
	LW6.1E.207	PRIMA I.® DOUBLE NOZZLE PENT Ø 3.5 CP

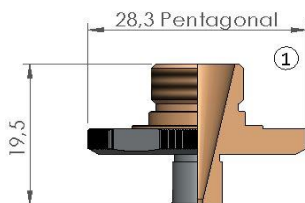

POZ	NUMER REFERENCYJNY	NAZWA
1	LW6.1G.699	PRIMA I.® NOZZLE PENT Ø 1.5 CP
	LW6.1G.700	PRIMA I.® NOZZLE PENT Ø 2.0 CP
	LW6.1G.701	PRIMA I.® NOZZLE PENT Ø 2.5 CP
	LW6.1G.702	PRIMA I.® NOZZLE PENT Ø 3.0 CP

Katalog części zamiennych dla PRIMA INDUSTRIE®

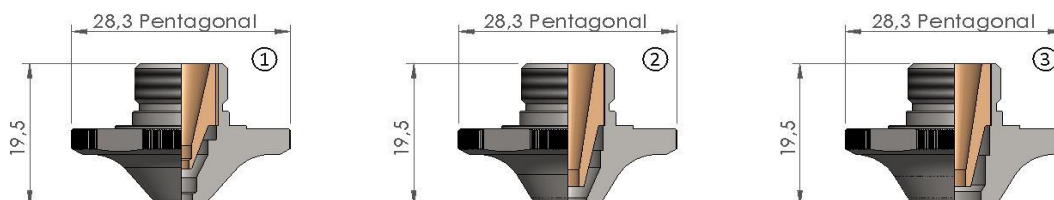

POZ	NUMER REFERENCYJNY	NAZWA
1	LW6.1G.200	PRIMA I.® DOUBLE NOZZLE PENT Ø 3.0
	LW6.1G.201	PRIMA I.® DOUBLE NOZZLE PENT Ø 3.5
	LW6.1G.202	PRIMA I.® DOUBLE NOZZLE PENT Ø 4.0
2	LW6.1G.203	PRIMA I.® DOUBLE NOZZLE PENT Ø 5.0
3	LW6.1G.204	PRIMA I.® DOUBLE NOZZLE PENT Ø 7.0

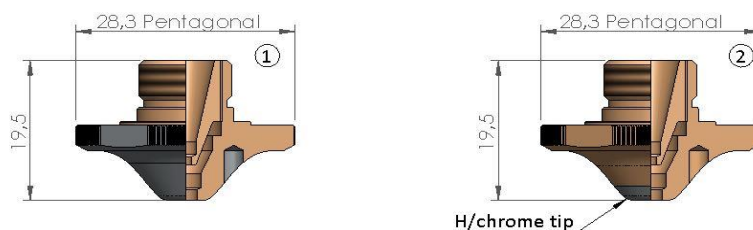

POZ	NUMER REFERENCYJNY	NAZWA
1	LW6.1G.680	PRIMA I.® DOUBLE NOZZLE PENT Ø 0.8 CP
	LW6.1G.681	PRIMA I.® DOUBLE NOZZLE PENT Ø 1.0 CP
	LW6.1G.682	PRIMA I.® DOUBLE NOZZLE PENT Ø 1.25 CP
	LW6.1G.683	PRIMA I.® DOUBLE NOZZLE PENT Ø 1.5 CP
	LW6.1G.684	PRIMA I.® DOUBLE NOZZLE PENT Ø 1.75 CP
	LW6.1G.685	PRIMA I.® DOUBLE NOZZLE PENT Ø 2.0 CP
	LW6.1G.686	PRIMA I.® DOUBLE NOZZLE PENT Ø 2.25 CP
	LW6.1G.687	PRIMA I.® DOUBLE NOZZLE PENT Ø 2.5 CP
	LW6.1G.688	PRIMA I.® DOUBLE NOZZLE PENT Ø 2.75 CP
	LW6.1G.689	PRIMA I.® DOUBLE NOZZLE PENT Ø 3.0 CP
2	LW6.1G.680	PRIMA I.® DOUBLE NOZZLE PENT Ø 0.8 CP
	LW6.1G.681	PRIMA I.® DOUBLE NOZZLE PENT Ø 1.0 CP
	LW6.1G.682	PRIMA I.® DOUBLE NOZZLE PENT Ø 1.25 CP
	LW6.1G.683	PRIMA I.® DOUBLE NOZZLE PENT Ø 1.5 CP
	LW6.1G.684	PRIMA I.® DOUBLE NOZZLE PENT Ø 1.75 CP
	LW6.1G.685	PRIMA I.® DOUBLE NOZZLE PENT Ø 2.0 CP
	LW6.1G.686	PRIMA I.® DOUBLE NOZZLE PENT Ø 2.25 CP
	LW6.1G.687	PRIMA I.® DOUBLE NOZZLE PENT Ø 2.5 CP
	LW6.1G.688	PRIMA I.® DOUBLE NOZZLE PENT Ø 2.75 CP
	LW6.1G.689	PRIMA I.® DOUBLE NOZZLE PENT Ø 3.0 CP

Katalog części zamiennych dla PRIMA INDUSTRIE®

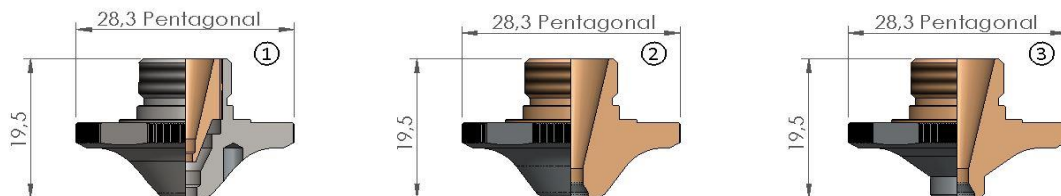

POZ	NUMER REFERENCYJNY	NAZWA
1	LW6.1G.800	PRIMA I.® DOUBLE NOZZLE PENT Ø 3.0
	LW6.1G.801	PRIMA I.® DOUBLE NOZZLE PENT Ø 3.5
	LW6.1G.802	PRIMA I.® DOUBLE NOZZLE PENT Ø 4.0
	LW6.1G.803	PRIMA I.® DOUBLE NOZZLE PENT Ø 5.0
	LW6.1G.804	PRIMA I.® DOUBLE NOZZLE PENT Ø 7.0
2	LW6.1G.522a	PRIMA I.® NOZZLE PENT Ø 3.0 CP
3	LW6.1G.524	PRIMA I.® NOZZLE PENT Ø 3.0 CP

Katalog części zamiennych dla PRIMA INDUSTRIE®

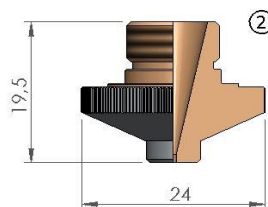
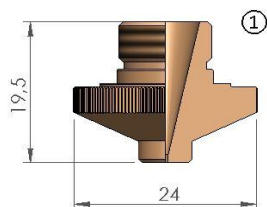

POZ	NUMER REFERENCYJNY	NAZWA
1		PRIMA I.® NOZZLE Ø 0.8
		PRIMA I.® NOZZLE Ø 1.0
		PRIMA I.® NOZZLE Ø 1.2
	LW6.1E.111	PRIMA I.® NOZZLE Ø 1.5
	LW6.1E.112	PRIMA I.® NOZZLE Ø 2.0
	LW6.1E.113	PRIMA I.® NOZZLE Ø 2.5
	LW6.1E.114	PRIMA I.® NOZZLE Ø 3.0
2		PRIMA I.® NOZZLE Ø 0.8 CP
		PRIMA I.® NOZZLE Ø 1.0 CP
		PRIMA I.® NOZZLE Ø 1.2 CP
	LW6.1E.111	PRIMA I.® NOZZLE Ø 1.5 CP
	LW6.1E.112	PRIMA I.® NOZZLE Ø 2.0 CP
	LW6.1E.113	PRIMA I.® NOZZLE Ø 2.5 CP
	LW6.1E.114	PRIMA I.® NOZZLE Ø 3.0 CP

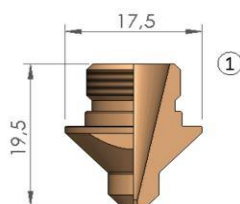

POZ	NUMER REFERENCYJNY	NAZWA
1	750.42.559	PRIMA I.® NOZZLE Ø 0.3
		PRIMA I.® NOZZLE Ø 1.0
	750.42.550	PRIMA I.® NOZZLE Ø 1.5
	750.42.551	PRIMA I.® NOZZLE Ø 2.0
	750.42.552	PRIMA I.® NOZZLE Ø 2.5
	750.42.553	PRIMA I.® NOZZLE Ø 3.0

Katalog części zamiennych dla PRIMA INDUSTRIE®

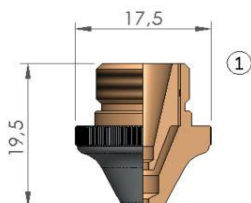

POZ	NUMER REFERENCYJNY	NAZWA
1	520.17.111	PRIMA I.® DOUBLE NOZZLE Ø 1.5 CP
	520.17.114	PRIMA I.® DOUBLE NOZZLE Ø 2.0 CP
	750.43.560	PRIMA I.® DOUBLE NOZZLE Ø 2.5 CP
	520.17.561	PRIMA I.® DOUBLE NOZZLE Ø 3.0 CP
	520.17.562	PRIMA I.® DOUBLE NOZZLE Ø 3.5 CP

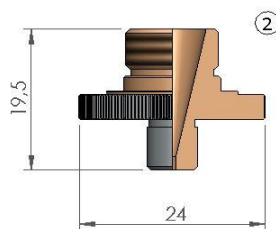
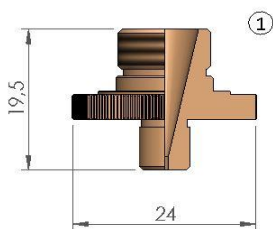

POZ	NUMER REFERENCYJNY	NAZWA
1		PRIMA I.® NOZZLE Ø 1.0
		PRIMA I.® NOZZLE Ø 1.2
	LW6.1G.500-LW6.1G.600	PRIMA I.® NOZZLE Ø 1.5
	LW6.1G.501-LW6.1G.601	PRIMA I.® NOZZLE Ø 2.0
	LW6.1G.502-LW6.1G.602	PRIMA I.® NOZZLE Ø 2.5
2	LW6.1G.503-LW6.1G.603	PRIMA I.® NOZZLE Ø 3.0
		PRIMA I.® NOZZLE Ø 1.0 CP
		PRIMA I.® NOZZLE Ø 1.2 CP
	LW6.1G.500-LW6.1G.600	PRIMA I.® NOZZLE Ø 1.5 CP
	LW6.1G.501-LW6.1G.601	PRIMA I.® NOZZLE Ø 2.0 CP
	PRIMA I.® NOZZLE Ø 2.5 CP	
	PRIMA I.® NOZZLE Ø 3.0 CP	

Katalog części zamiennych dla PRIMA INDUSTRIE®

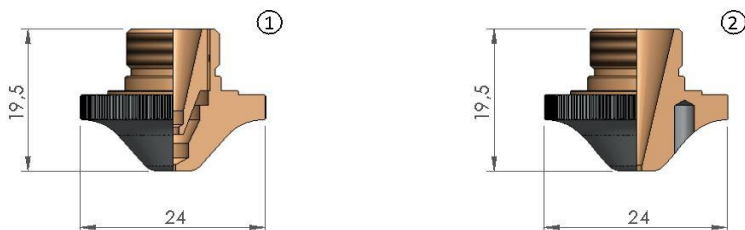

POZ	NUMER REFERENCYJNY	NAZWA
1	105.970.000.010	PRIMA I.® DOUBLE NOZZLE Ø 0.8 CP
	105.970.000.003	PRIMA I.® DOUBLE NOZZLE Ø 1.0 CP
	105.970.000.008	PRIMA I.® DOUBLE NOZZLE Ø 1.25 CP
	105.970.000.004	PRIMA I.® DOUBLE NOZZLE Ø 1.5 CP
	105.970.000.009	PRIMA I.® DOUBLE NOZZLE Ø 1.75 CP
	105.970.000.005	PRIMA I.® DOUBLE NOZZLE Ø 2.0 CP
	105.970.000.006	PRIMA I.® DOUBLE NOZZLE Ø 2.5 CP
	105.970.000.007	PRIMA I.® DOUBLE NOZZLE Ø 3.0 CP
2	LW6.1G.604	PRIMA I.® NOZZLE Ø 1.5 CP
		PRIMA I.® NOZZLE Ø 1.75 CP
	LW6.1G.605	PRIMA I.® NOZZLE Ø 2.0 CP
	LW6.1G.606	PRIMA I.® NOZZLE Ø 2.5 CP
	LW6.1G.607	PRIMA I.® NOZZLE Ø 3.0 CP

Katalog części zamiennych dla PRIMA INDUSTRIE®

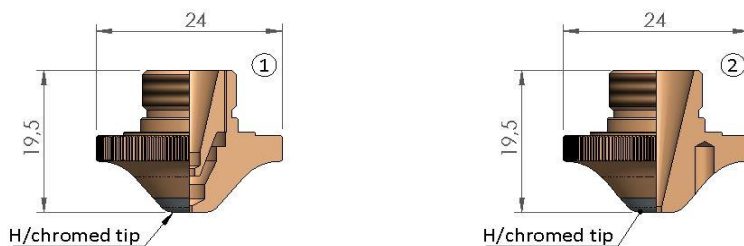

POZ	NUMER REFERENCYJNY	NAZWA
1	105.970.000.010	PRIMA I.® DOUBLE NOZZLE Ø 0.8 CP
	105.970.000.003	PRIMA I.® DOUBLE NOZZLE Ø 1.0 CP
	105.970.000.008	PRIMA I.® DOUBLE NOZZLE Ø 1.25 CP
	105.970.000.004	PRIMA I.® DOUBLE NOZZLE Ø 1.5 CP
	105.970.000.009	PRIMA I.® DOUBLE NOZZLE Ø 1.75 CP
	105.970.000.005	PRIMA I.® DOUBLE NOZZLE Ø 2.0 CP
	105.970.000.006	PRIMA I.® DOUBLE NOZZLE Ø 2.5 CP
	105.970.000.007	PRIMA I.® DOUBLE NOZZLE Ø 3.0 CP
2	LW6.1G.604	PRIMA I.® NOZZLE Ø 1.5 CP
		PRIMA I.® NOZZLE Ø 1.75 CP
	LW6.1G.605	PRIMA I.® NOZZLE Ø 2.0 CP
	LW6.1G.606	PRIMA I.® NOZZLE Ø 2.5 CP
	LW6.1G.607	PRIMA I.® NOZZLE Ø 3.0 CP

Katalog części zamiennych dla PRIMA INDUSTRIE®



POZ	NUMER REFERENCYJNY	NAZWA
1	LW6.1G.633	PRIMA I.® NOZZLE PENT Ø 1.5 CP
	LW6.1G.635	PRIMA I.® NOZZLE PENT Ø 2.0 CP
	LW6.1G.637	PRIMA I.® NOZZLE PENT Ø 2.5 CP
2	LW6.1G.643	PRIMA I.® DOUBLE NOZZLE PENT Ø 1.5 CP
	LW6.1G.645	PRIMA I.® DOUBLE NOZZLE PENT Ø 2.0 CP
	LW6.1G.647	PRIMA I.® DOUBLE NOZZLE PENT Ø 2.5 CP

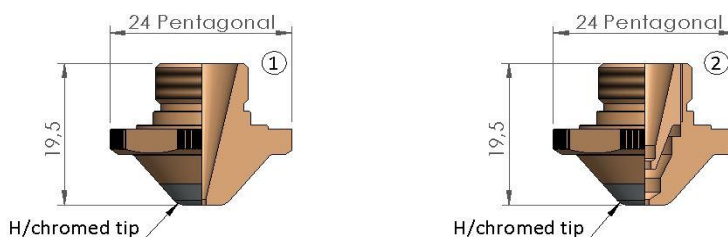

POZ	NUMER REFERENCYJNY	NAZWA
	LW6.1G.633	PRIMA I.® NOZZLE PENT Ø 1.5 CP
	LW6.1G.635	PRIMA I.® NOZZLE PENT Ø 2.0 CP
	LW6.1G.637	PRIMA I.® NOZZLE PENT Ø 2.5 CP
2	LW6.1G.643	PRIMA I.® DOUBLE NOZZLE PENT Ø 1.5 CP
	LW6.1G.645	PRIMA I.® DOUBLE NOZZLE PENT Ø 2.0 CP
	LW6.1G.647	PRIMA I.® DOUBLE NOZZLE PENT Ø 2.5 CP

Katalog części zamiennych dla PRIMA INDUSTRIE®

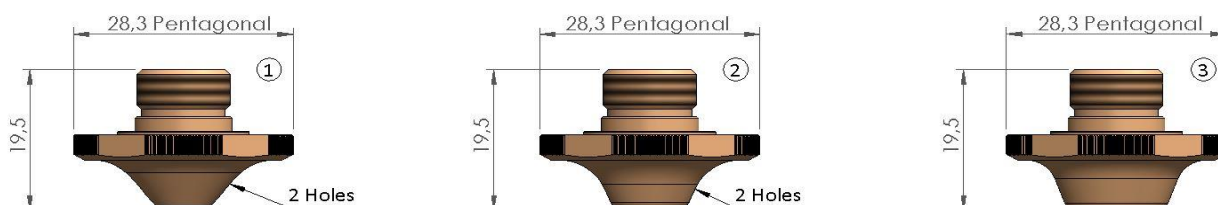

POZ	NUMER REFERENCYJNY	NAZWA
1		PRIMA I.® DOUBLE NOZZLE PENT Ø 2.5 - SS
		PRIMA I.® DOUBLE NOZZLE PENT Ø 3.0 - SS
		PRIMA I.® DOUBLE NOZZLE PENT Ø 4.0 - SS
2		PRIMA I.® DOUBLE NOZZLE PENT Ø 6.0 - SS
3		PRIMA I.® DOUBLE NOZZLE PENT Ø 10.0 - SS

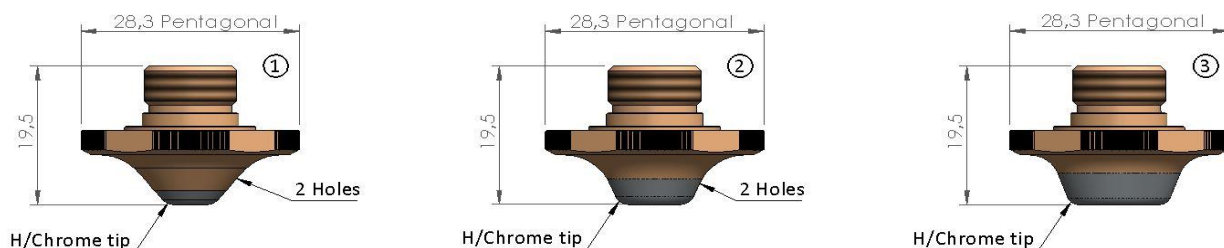

POZ	NUMER REFERENCYJNY	NAZWA
1		PRIMA I.® DOUBLE NOZZLE PENT Ø 2.5 CP - SS
		PRIMA I.® DOUBLE NOZZLE PENT Ø 3.0 CP - SS
		PRIMA I.® DOUBLE NOZZLE PENT Ø 4.0 CP - SS
2		PRIMA I.® DOUBLE NOZZLE PENT Ø 6.0 CP - SS
3		PRIMA I.® DOUBLE NOZZLE PENT Ø 10.0 CP - SS

Katalog części zamiennych dla PRIMA INDUSTRIE®

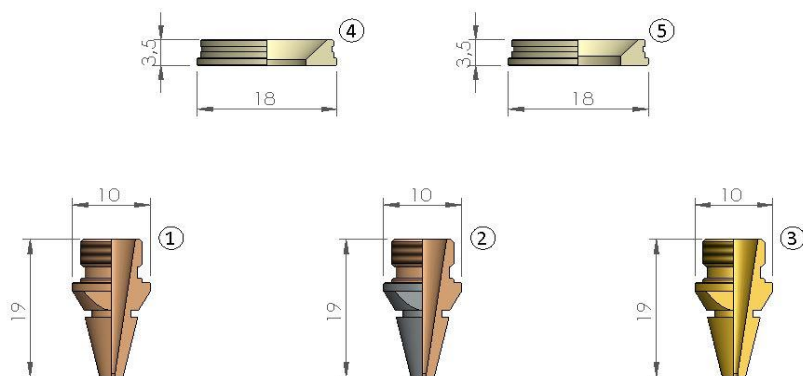

POZ	NUMER REFERENCYJNY	NAZWA
1		PRIMA I.® NOZZLE Ø 1.0 CONICAL
		PRIMA I.® NOZZLE Ø 1.2 CONICAL
		PRIMA I.® NOZZLE Ø 1.5 CONICAL
		PRIMA I.® NOZZLE Ø 1.7 CONICAL
		PRIMA I.® NOZZLE Ø 2.0 CONICAL
		PRIMA I.® NOZZLE Ø 2.5 CONICAL
		PRIMA I.® NOZZLE Ø 3.0 CONICAL
2		PRIMA I.® NOZZLE Ø 1.0 CP
		PRIMA I.® NOZZLE Ø 1.2 CP
	485.73.431	PRIMA I.® NOZZLE Ø 1.5 CP
		PRIMA I.® NOZZLE Ø 1.7 CP
	485.73.433	PRIMA I.® NOZZLE Ø 2.0 CP
		PRIMA I.® NOZZLE Ø 2.5 CP
	PRIMA I.® NOZZLE Ø 3.0 CP	
3	485.73.331	PRIMA I.® NOZZLE Ø 1.5 BRASS
	485.73.333	PRIMA I.® NOZZLE Ø 2.0 BRASS
	485.73.334	PRIMA I.® NOZZLE Ø 2.5 BRASS
4	480.73.107	PRIMA I.® INSULATING RING-PLASTIC - HEAD 5" - ID 10"
5		PRIMA I.® INSULATING RING-PLASTIC - HEAD 7.5" - ID 11"

Katalog części zamiennych dla PRIMA INDUSTRIE®

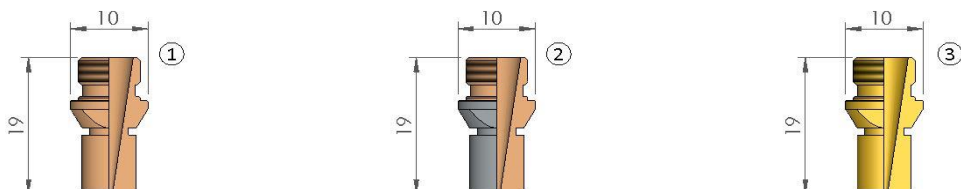

POZ	NUMER REFERENCYJNY	NAZWA
1		PRIMA I.® NOZZLE Ø 1.0
		PRIMA I.® NOZZLE Ø 1.2
		PRIMA I.® NOZZLE Ø 1.5
		PRIMA I.® NOZZLE Ø 1.7
		PRIMA I.® NOZZLE Ø 2.0
		PRIMA I.® NOZZLE Ø 2.5
		PRIMA I.® NOZZLE Ø 3.0
2		PRIMA I.® NOZZLE Ø 1.0 CP
		PRIMA I.® NOZZLE Ø 1.2 CP
	485.73.421	PRIMA I.® NOZZLE Ø 1.5 CP
		PRIMA I.® NOZZLE Ø 1.7 CP
	485.73.422	PRIMA I.® NOZZLE Ø 2.0 CP
	485.73.423	PRIMA I.® NOZZLE Ø 2.5 CP
	485.73.424	PRIMA I.® NOZZLE Ø 3.0 CP
3		PRIMA I.® NOZZLE Ø 1.0 BRASS
	485.73.321	PRIMA I.® NOZZLE Ø 1.5 BRASS
	485.73.322	PRIMA I.® NOZZLE Ø 2.0 BRASS
	485.73.323	PRIMA I.® NOZZLE Ø 2.5 BRASS
	485.73.324	PRIMA I.® NOZZLE Ø 3.0 BRASS

Katalog części zamiennych dla PRIMA INDUSTRIE®

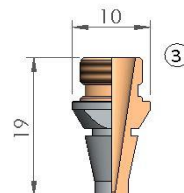
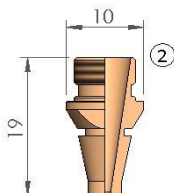
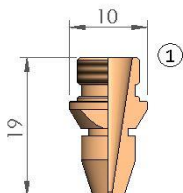

POZ	NUMER REFERENCYJNY	NAZWA
1		PRIMA I.® NOZZLE Ø 1.0
		PRIMA I.® NOZZLE Ø 1.2
		PRIMA I.® NOZZLE Ø 1.5
		PRIMA I.® NOZZLE Ø 1.7
		PRIMA I.® NOZZLE Ø 2.0
		PRIMA I.® NOZZLE Ø 2.5
2		PRIMA I.® NOZZLE Ø 3.0
		PRIMA I.® NOZZLE Ø 1.5
		PRIMA I.® NOZZLE Ø 2.0
3		PRIMA I.® NOZZLE Ø 2.5
		PRIMA I.® NOZZLE Ø 3.0
	485.73.451	PRIMA I.® NOZZLE Ø 1.5 CP
	485.73.452	PRIMA I.® NOZZLE Ø 2.0 CP
	485.73.453	PRIMA I.® NOZZLE Ø 2.5 CP
		PRIMA I.® NOZZLE Ø 3.0 CP

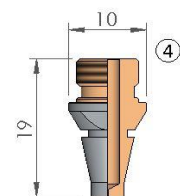
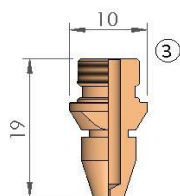
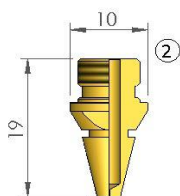
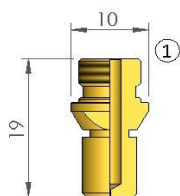

POZ	NUMER REFERENCYJNY	NAZWA
1		PRIMA I.® NOZZLE Ø 0.3 BRASS
2		PRIMA I.® NOZZLE Ø 0.3 BRASS
3		PRIMA I.® NOZZLE Ø 0.3
4	485.73.455	PRIMA I.® NOZZLE Ø 0.3 CP

Katalog części zamiennych dla PRIMA INDUSTRIE®

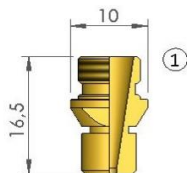

POZ	NUMER REFERENCYJNY	NAZWA
1	490.1N.301	PRIMA I.® NOZZLE Ø 2.0 BRASS
	490.1N.302	PRIMA I.® NOZZLE Ø 2.5 BRASS
		PRIMA I.® NOZZLE Ø 3.0 BRASS

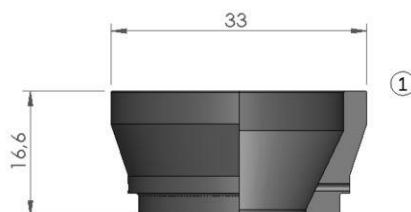

POZ	NUMER REFERENCYJNY	NAZWA
1	LW6.59.121	PRIMA I.® SENSOR INSULTAOR



POZ	NUMER REFERENCYJNY	NAZWA
1	820.63.150	PRIMA INDUSTRIE® SENSOR CABLE 150 MM COMPATIBLE
	756.63.923	PRIMA INDUSTRIE® SENSOR CABLE 230 MM COMPATIBLE
	523.P6.935	PRIMA INDUSTRIE® SENSOR CABLE 350 MM COMPATIBLE

POZ	NUMER REFERENCYJNY	NAZWA
	1058.36520.720	PRIMA I.® LENS GASKET