



A registered trademark of SNA Europe Group

NOWE ZESTAWY NARZĘDZI DO SILNIKA & ROZRZĄDU 2015

NARZĘDZIA DO ROZRZĄDU

BMW / MINI Str. **03**

AUTA FIAT CHRYSLER Str. **13**

FORD Str. **20**

PEUGEOT / CITROËN Str. **27**

RENAULT / NISSAN Str. **34**

SAAB Str. **41**

VAUXHALL / GM / OPEL / CHEVROLET Str. **47**

VOLKSWAGEN / AUDI / SEAT / ŠKODA Str. **52**

VOLVO Str. **65**

NARZĘDZIA DO SILNIKA

ŚWIECE Str. **74**

WTRYSKI Str. **77**



NARZEDZIA DO ROZRZĄDU

BMW / MINI

SILNIKI BENZYNOWE

BE502101

Silniki 1.8 - 2.0

4**BE501102**

Silniki 1.6

5**BE502103**

Silniki 1.6 - 2.0

6

SILNIKI DIESELA

BE502204

Silniki 2.0 - 2.5 - 3.0

8**BE503201**

Silniki 1.6 - 2.0

10**BE504201**

Silniki 1.6

11

KOMPLETNY ZESTAW NARZĘDZI PASUJĄCY DO BMW 1.8-2.0 BENZYNA

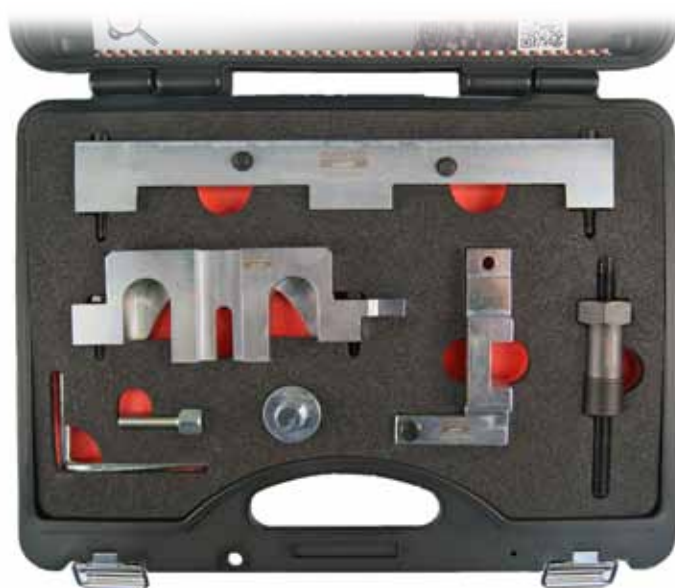

Kompletne zestawy

BE502101

Marka	Model	Silnik	Kod silnika
BMW	Serie 3 (E46)	1.8, 2.0	N42B18A, N42B20A, N46B18, N42B20

Składniki

NARZĘDZIE DO USTAWIANIA SENSORA PRZEKŁADNI

BE50210101

11 9 350

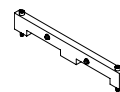

NARZĘDZIE DO USTAWIANIA ROZRZĄDU

BE50210102

11 9 290
11 9 291
11 9 293

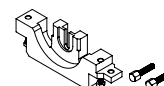

ŚRUBA M8

BE50210103

/



NARZĘDZIE UDO USTAWIANIA POCZĄTKU ROZRZĄDU

BE50210104

11 9 290
11 9 292



NARZĘDZIE DO WSTĘPNEGO NACIĄGU ŁAŃCUCHA

BE50210105

11 9 340



NARZĘDZIE DO OBROTU POCZĄTKU ROZRZĄDU

BE50210106

11 9 270



TRZPIEŃ NAPINAJĄCY KOŁO ZAMACHOWE

BE50210107

11 9 190
11 5 120

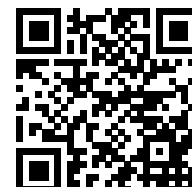
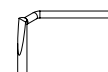

KOMPLETNY ZESTAW NARZĘDZI PASUJĄCY DO BMW 1.6 BENZYNA

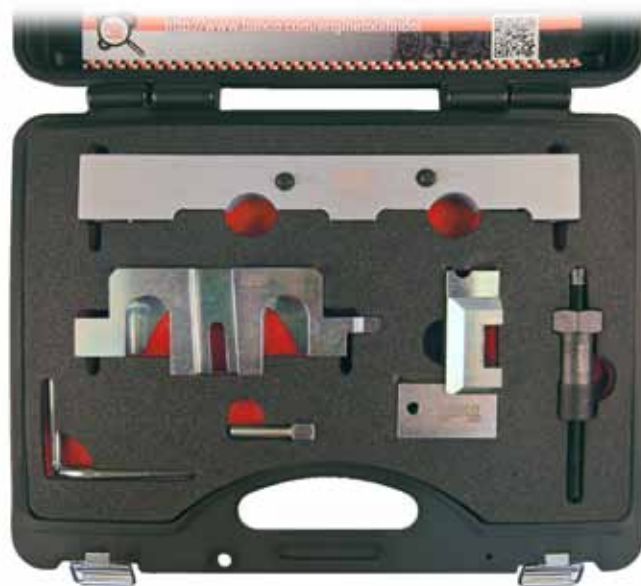

Kompletne zestawy

BE502102

Marka	Model	Silnik	Kod silnika	Rok
BMW	Serie 1 (E81/82/87/88)	1.6	N45 B16A	2004 - 2007
	Serie 3 (E46)	1.6	N40 B16A	2002 - 2005
	Serie 3 (E90/91/92/93)	1.6	N45 B16A	2005 - 2007
	Serie 3 (E46)	1.6	N45 B16A	2005 - 2007
	Serie 1 (E81/82/87/88)	1.6	N45T B16AC	2005 - 2007
	Serie 3 (E90/91/92/93)	1.6	N45T B16AC	2005 - 2007

Składniki

NARZĘDZIE DO USTAWIANIA SENSORA PRZEKŁADNI

BE50210201

11 7 260

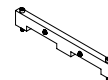

NARZĘDZIE DO USTAWIANIA ROZRZĄDU 1

BE50210202

**11 7 250
11 7 251**

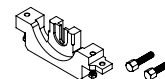

NARZĘDZIE DO USTAWIANIA ROZRZĄDU 2

BE50210203

**11 7 250
11 7 252**



NARZĘDZIE DO WSTĘPNEGO NACIĄGU ŁAŃCUCHA

BE50210105

11 9 340

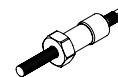

ŚRUBA M8

BE50210103

/



TRZPIEŃ NAPINAJĄCY KOŁO ZAMACHOWE

BE50210107

**11 9 190
11 5 120**

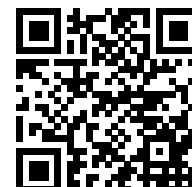
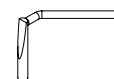

KOMPLETNY ZESTAW NARZĘDZI PASUJĄCY DO BMW 1.6-2.0 BENZYNA

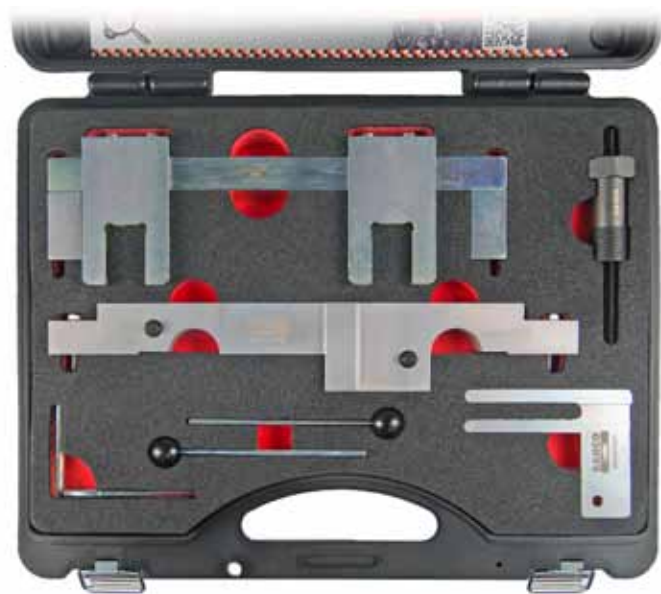

Kompletne zestawy

BE502103

Marka	Model	Silnik	Kod silnika	Rok
BMW	Serie 1 116i	1.6	N43 B16A/AA	2007 - 2008
	Serie 1 116i	1.6	N43 B16AA	2009 - 2010
	Serie 1 116i	2.0	N43 B20K0	2009 - 2012
	Serie 1 116i	2.0	N43 B20K0	2008 - 2012
	Serie 1 118i	2.0	N43 B20AY	2006 - 2013
	Serie 1 120i	2.0	N43 B20A	2006 - 2013
	Serie 1 120i	2.0	N43 B20A	2006 - 2013
	Serie 1 120i	2.0	N43 B20AA	2007 - 2013
	Serie 3 316i	1.6	N43 B16AA/O0	2007 - 2011
	Serie 3 318i	2.0	N43 B20AY	2007 - 2011
	Serie 3 318i	2.0	N43 B20U0	2010 - 2013
	Serie 3 320i	2.0	N43 B20A	2007 - 2013
	Serie 3 320i	2.0	N43 B20A/AA	2007 - 2013
Serie 5 520i	2.0	N43 B20A	2007 - 2010	

Składniki

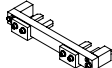
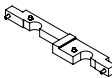
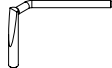
NARZĘDZIE DO USTAWIANIA WAŁU	BE50210301	11 8 700	
NARZĘDZIE DO USTAWIANIA ROZRZĄDU	BE50210302	11 8 690 11 8 691 11 8 692 11 8 693	
NARZĘDZIE SENSORA ROZRZĄDU	BE50210303	11 8 710 11 8 711 11 8 712	
TRZPIEŃ NAPINAJĄCY KOŁO ZAMACHOWE	BE50210107	11 9 190 11 5 120	

Składniki

TRZPIEŃ DO WAŁU

BE50210305

EN-6130
11 3 340

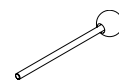

NARZĘDZIE DO WSTĘPNEGO NACIĄGU
ŁAŃCUCHA

BE50210105

11 9 340

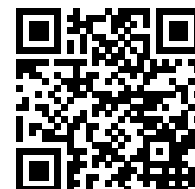
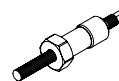

KOMPLETNY ZESTAW NARZĘDZI PASUJĄCY DO BMW 2.0 - 2.5 - 3.0 DIESEL



Kompletne zestawy

BE502204

Marka	Model	Silnik	Kod silnika	Rok
BMW	118D. (E87)		2.0 4D 1, 2.0 4D 4;	2003 - 2007
	120D. (E87)			2003 - 2007
	318D/TD. (E46/E90/91)		3.0 6D 2, 3.0 6D 1, 3.0 6D	2000 - 2008
	320D/CD. (E46/E90/91)			1997 - 2008
	325D. (E90/91/92/93)			2006 - 2009
	330D/XD/CD. (E46/E90/91/92/93)		3, 3.0 6D 4, 3.0 6D 5;	1998 - 2008
	335D. (E90/91/92)			2006 - 2009
	520D. (E39/E60/61)		2.5 6D 1, 2.5 6D 2	1999 - 2009
	525D/XD. (E39/E60/61)			1999 - 2009
	530D/XD. (E39/E60/61)	2.0 (M47)	2.0 4D 1, 2.0 4D 4;	1998 - 2009
	535D. (E60/61)			2004 - 2009
	635D. (E63/64)		2004 - 2009	
	730D/LD. (E38/E65/66)	3.0 6D 2, 3.0 6D 1, 3.0 6D	1998 - 2008	
	X3 (E83)		2003 - 2007	
	X3 (E83)	3.0 (M57)	3, 3.0 6D 4, 3.0 6D 5;	2003 - 2009
	X5 (E70)			2000 - 2009
	1 SERIES (E81/82/87/88)		2.5 6D 1, 2.5 6D 2	
	3 SERIES (E46/E90/91/92/93)		20 4D 4	2003- 2007
	5 SERIES (E39/E60/61)		20 4D 4	2003 - 2006
			30 6D 2 3 4 5	2003 - 2011
	7 SERIES (E38/E65/66)		20 4D 4	2003 - 2009
			30 6D 2 3 4 5	2003 - 2011
	X3 (E83)		30 6D 2 3 4 5	2002 - 2005
	X5 (E70)		30 6D 2 3 4 5	2003 - 2010
	X6 (E71/72)		30 6D 2 3 4 5	2008 - 2010
LAND ROVER	Freelander, Rang Rover	2.0	20 4D 3/td4, 30 6D 1/td4	-
MG-ROVER	75, MG	3.0		(99-04)

Składniki

NARZĘDZIE BLOKADY ROZRZĄDU	BE50220401	11 6 320 11 6 322	
TRZPIEŃ DO WAŁU	BE50210305	EN-6130 11 3 340	
TRZPIEŃ NAPINAJĄCY KOŁO ZAMACHOWE 1	BE50220403	11 2 300	
TRZPIEŃ NAPINAJĄCY KOŁO ZAMACHOWE 2	BE50220404	11 5 180	
TRZPIEŃ NAPINAJĄCY KOŁO ZAMACHOWE 3	BE50220405	11 6 080	



KOMPLETNY ZESTAW NARZĘDZI PASUJĄCY DO BMW-MINI 1.6-2.0 DIESEL



Kompletne zestawy

BE503201

Marka	Model	Silnik	Kod silnika
BMW	X1 (E84)	2.0 D	N47D20A, N47D20C, N47D20D, N47D20O, N47D20U, N47SD20B, N47SD20D, N47TD20K, N47TD20O, N47TD20U, N47D16
	X3 (E83, F25)	2.0 D	
	Serie 1 (E81/82/87/88, F20)	2.0 D	
	Serie 1 (F20/21), Serie 3 (E90/91/92/93)	1.6 D	
	Serie 3 (E90/91/92/93)	2.0 D	
	Serie 5 (E60/61, F10/11)	2.0 D	
MINI	Mini (R56/57)	1.6 D; 2.0 D	N47C16K, N47C16, N47C20K, N47C20U
	Clubman (R55)		
	Countryman (R60)	2.0 D	
	Coupe (R58)		
	Paceman (R61)	1.6 D; 2.0 D	
	Clubvan (R55)		

Składniki

NARZĘDZIE DO KOŁA PASOWEGO WAŁU

BE50320101

11 6 480



TRZPIEŃ NAPINAJĄCY KOŁO
ZAMACHOWE

BE50320102

11 5 320



NARZĘDZIE DO USTAWIANIA ROZRZĄDU

BE50320103

11 8 760



TRZPIEŃ DO WAŁU

BE50210305

**EN-6130
11 3 340**



NARZĘDZIE DO CIŚNIENIWEJ POMPY
PALIWOWEJ

BE50320105

11 8 740



KOMPLETNY ZESTAW NARZĘDZI PASUJĄCY DO MINI-PSA 1.6 DIESEL



Kompletne zestawy

BE504201

Marka	Model	Silnik	Kod silnika	Rok
PEUGEOT	1007	1.6 Hdi	DV6TED4 (9HZ)	2006-2010
	206		DV6TED4 (9HZ)	2004-2007
	206		DV6TED4 (9HY)	2004-2007
	206		DV6ATED4 (9HX)	2004-2007
	206 CC		DV6TED4 (9HZ)	2005-2007
	207		DV6ATED4 (9HX)	2006-2010
	207		DV6TED4 (9HZ)	2006-2010
	207		DV6TED4 (9HY)	2006-2010
	207		DV6TED4 (9HV)	2007-2010
	207		DV6C (9HR)	2010-2013
	207		DV6D (9HP)	2010-2013
	207 CC		DV6TED4 (9HZ)	2007-2010
	207 CC		DV6C (9HR)	2010-2014
	208		DV6C (9HR)	2012-2014
	208		DV6C (9HP)	2012-2014
	208		DV6C (9HD)	2012-2014
	301		DV6DTED (9HP)	2012-2014
	301		DV6DM (9HJ)	2012-2014
	307		DV6TED4 (9HY)	2004-2008
	307		DV6ATED4 (9HX)	2004-2008
	307		DV6TED4 (9HZ)	2005-2008
	307		DV6TED4 (9HV)	2005-2008
	308		DV6TED4 (9HY)	2007-2011
	308		DV6ATED4 (9HX)	2007-2011
	308		DV6TED4 (9HZ)	2007-2011
	308		DV6TED4 (9HV)	2007-2011
	308		DV6C (9HR)	2009-2014
	308		DV6DTED (9HP)	2009-2014
308	DV6DTEDM (9HJ)	2011-2014		
308	DV6CM (9HG)	2011-2014		

Marka	Model	Silnik	Kod silnika	Rok
CITROËN	C2	1.6 Hdi	9HZ (DV6TED4)	2007-2010
	C3 I/II		9HZ (DV6TED4)	2005-2010
	C3 I/II		9HX (DV6ATED4)	2005-2010
	C3 I/II		9HY (DV6TED4)	2008-2010
	C3 III		9HX (DV6ATED4)	2010-2010
	C3 III		9HR (DV6C)	2010-2012
	C3 III		9HP (DV6DTED)	2010-2014
	C3 Picasso		9HX (DV6ATED4)	2009-2010
	C3 Picasso		9HZ (DV6TED4)	2009-2010
	C3 Picasso		9HR (DV6C)	2010-2014
	C3 Picasso		9HP (DV6DTED)	2010-2014
	DS3/DS3 Cabrio		9HP (DV6DTED)	2009-2014
	DS3/DS3 Cabrio		9HR (DV6C)	2009-2012
	DS3/DS3 Cabrio		9HL (DV6C)	2010-2012
	C-Elysee		9HP (DV6DTED)	2012-2014
	C-Elysee		9HJ (DV6DM)	2012-2014
	Xsara Picasso		9HY (DV6TED4)	2004-2010
Xsara Picasso	9HZ (DV6TED4)	2005-2010		

Pomocnicze narzędzia systemowe nie są przeznaczone do silników Peugeot-Citroën

Sprawdź wszystkie zastosowania w instrukcji obsługi

Składniki

NARZĘDZIE DO BLOKOWANIA KOŁA
ZAMACHOWEGO

BE50420101

11 9 850
11 9 851
11 9 852

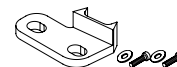

NARZĘDZIE BLOKUJĄCE KOŁO ZĘBATE
ROZRZĄDU

BE50420102

0194-A
11 9 790
21-260
303-732
999-7233
2000023000
2000023100



NARZĘDZIE DO BLOKOWANIA KOŁA
ZAMACHOWEGO

BE50420103

0194-C
303-734
21-262
2000022500
999-7169



NARZĘDZIE DO USTAWIANIA WAŁU

BE50420104

0194-B
11 9 790
303-735
21-263
2000023200
999-7122



TRZPIEŃ DO WAŁU

BE50210305

EN-6130
11 3 340

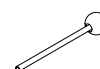



AUTA FIAT CHRYSLER

SILNIKI BENZYNOWE

BE501101

Silniki 1.4 Multiair

14

BE501102

Silniki 0.9 Twinair Turbo

15

SILNIKI DIESELA

BE501203

Silniki 1.6 - 1.9 - 2.0 - 2.4 JTD MultiJet

16

BE501204

Silniki 1.3 JTD MultiJet

18

KOMPLETNY ZESTAW NARZĘDZI PASUJĄCY DO GRUPY FCA 1.4 MULTIAIR



Kompletne zestawy

BE501101

Marka	Model	Silnik	Kod silnika
ALFA ROMEO	Mito, Giulietta	1.4 Multiair 105, 1.4 Multiair 170 Turbo	955A6.000, 940A2.000, 955A8.000
		1.4 Multiair 135 Turbo	955A2.000, 955A7.000
FIAT	Punto, Punto Evo	1.4 Multiair 105, 1.4 Multiair 170 Turbo	955A6.000, 955A8.000

Składniki

NARZĘDZIE ROZRZĄDU

BE50110101

2 000 034 400

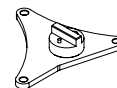

NARZĘDZIE NAPINAJĄCE

BE50110102

1 860 987 000



TRZPIEŃ DO BE50110104

BE50110103

2 000 004 500



NARZĘDZIE WAŁU

BE50110104

**2 000 004 500
2 190 754 500**

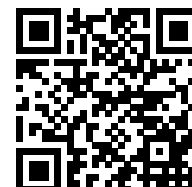
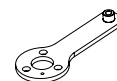

KOMPLETNY ZESTAW NARZĘDZI PASUJĄCY DO GRUPY FCA 0.9 BENZYNA TWINAIR



Kompletne zestawy

BE501102

Marka	Model	Silnik	Kod silnika	Rok
FIAT	500, Panda, Punto, 500L, 500C, Panda	0.9 Twinair Turbo	312A2.000	2012 - 2014
LANCIA	Ypsilon		312A4.000	
ALFA ROMEO	MiTo		312A2.000	2011 - 2014

Składniki

NARZĘDZIE BLOKADY WAŁU

BE50110201

2 000 035 200

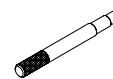

NARZĘDZIE BLOKADY ROZRZĄDU

BE50110202

2 000 035 100

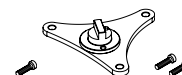

NARZĘDZIA BLOKADY KOŁA
ZAMACHOWEGO

BE50110203

2 000 035 300

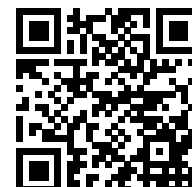

KOMPLETNY ZESTAW NARZĘDZI PASUJĄCY DO GRUPY FCA 1.6-1.9- 2.0-2.4 DIESEL



Kompletne zestawy

BE501203

Marka	Model	Silnik	Kod silnika
ALFA ROMEO	145, 146, 147, 156, 159,166, Giulietta, MiTo	1.6D Multijet 115	955A4.000, 350A3.000, 192B4.000
		1.6D Multijet 120	198A2.000, 350A2.000, 955A3.000, 192A8.000
		1.6D Multijet 90	198A6.000, 263A4.000, 263A5.000
		1.6D Multijet 105	198A3.000, 199B5.000
		1.6D JTDM 16V	940A3.000, 955A3.000, 955A4.000
		1.9D	188A3.000
		1.9D 16V/Multijet 150	939A2.000
		1.9D JTD	188B2.000, 323.02, 371.01, 937A2.000, 182B4.000, 182B9.000, 188A2.000, 188A7.000
		1.9D JTD 100	192A9.000
		1.9D JTD 110	186A6.000
		1.9D JTD 115	186A8.000, 192A1.000
		1.9D JTD 80	192A3.000
		1.9D JTD 16V	192B1.000, 192A5.000
FIAT	Punto, Punto evo, Grande Punto, Brava/Bravo Marea, Linea, Idea, Weekend, Stilo, Doblo/Cargo/WorkUp, Multipla, Delta, Musa, 500L	1.9D Multijet 100	186A9.000
		1.9D Multijet 120	939A1.000
		1.9D Multijet 130	199A5.000
		1.9D Multijet 105	223A7.000, 223B1.000
		1.9D Multijet 140	192A5.000
LANCIA	Lybra, Thesis	1.9D Multijet 150	937A5.000
		1.9D Multijet 90	192B5.000
		1.9D TD 100	182A7.000
		1.9D TD 75	182A8.000
		2.0 D Multijet 135	D20AA, 263A1.000
		2.0 D Multijet 165	198A5.000
		2.0 D JTDM 16V	939B3.000, 939B4.000, 940A4.000, 940A5.000, 940A7.000, 940A8.000
		2.4D JTD	838A8.000, 839A5.000, 839A6.000, 841C.000, 325.01, 342.02, 362.02
		2.4D JTD 20V	841G.000, 841H.000, 841P.000, 939A3.000
		2.4D JTD 125	185A2.000
		2.4D JTD 130	185A6.000

Marka	Model	Silnik	Kod silnika
OPEL	Vectra, Zafira, Astra, Insigna, Signum	1.9 CDTi	Z19DT
		1.9 CDTi	Z19DTH, Z19DTJ, Z19DTL
SAAB	9-3, 9-5	1.9 TiD	A19DTR, Z19DT, Z19DTH, Z19DTR
		1.9 TTiD	
		1.9 XTTiD	

Składniki

NARZĘDZIE BLOKADY WAŁU	BE50120301	1 860 905 000 EN-46788	
TRZPIEŃ BLOKADY ROZRZĄDU	BE50120302	1 870 896 900 EN-46789	
NARZĘDZIE BLOKADY WAŁU	BE50120303	2 000 003 000	
TRZPIEŃ DO BE50120303	BE50110103	2 000 004 500	
TRZIEŃ DO BE50120301	BE50120305	1 860 905 010	

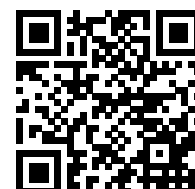

KOMPLETNY ZESTAW NARZĘDZI PASUJĄCY DO GRUPY FCA 1.3 JTD MJ



Kompletne zestawy

BE501204

Marka	Model	Silnik	Kod silnika		
FIAT	500, 500C, 500L, Panda, Panda Classic, Punto, Grande Punto, Punto Evo, Qubo, Idea, Doblo, Doblo cargo, Doblo work up, Strada pick up, Fiorino	1.3 JTD Multi-jet	188A9.000 , 199A3.000, 199A3.000, 199B1.000		
ALFA ROMEO	Mito				
LANCIA	Ypsilon, Musa				
FIAT	500, 500C, 500L, Panda, Panda Classic, Punto, Grande Punto, Punto Evo, Qubo, Idea, Doblo, Doblo cargo, Doblo work up, Strada pick up, Fiorino	1.3D Multijet 75	199A2.000, 169A1.000, 199A2.000, 199A9.000		
		1.3D Multijet 95	199B1.000		
		1.3D JTD/Multijet 70	188A8.000		
		1.3D Multijet 70	199B2.000		
		ALFA ROMEO	Mito	1.3D Multijet 85	223A9.000
				LANCIA	Ypsilon, Musa
		1.3D Multijet 95	199B1.000		
FORD	Ka	1.3 D TDCi	169A1.000 (FD4) / BAAA/B		
OPEL	Corsa, Agila, Meriva, Combo Tour, Astra	1.3 CDTi	Z13DT, Z13DTH, Z13DTJ		
SUZUKI	Ignis, Swift, Wagon R+	1.3 DDis	Z13DT, Z13DTH, Z13DTJ		

Składniki

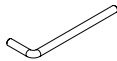
UCHWYT KOŁA PASOWEGO WAŁU 1	BE50120401	1 870 900 300 KM-662-C 303-1468	
NAPINACZ ŁAŃCUCHA ROZRZĄDU	BE50120402	1 870 900 400	
NARZĘDZIE BLOKADY ROZRZĄD	BE50120403	1 860 985 000 1 871 000 900 EN-46781 313-1472 09917 68610	
UCHWYT KOŁA PASOWEGO WAŁU 2	BE50120404	1 871 000 200 KM-661-C 303-1469	
TRZPIEŃ BLOKADY WAŁU	BE50120405	EN-46785 09912 38300	

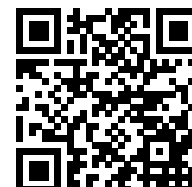

FORD

SILNIKI BENZYNOWE

BE505101

Silniki 1.25 - 1.4 - 1.6

21

BE505102

Silniki 1.0 EcoBoost

22

SILNIKI DIESELA

BE505203

Silniki 2.0 - 2.2 - 2.4 Duratorq TDCI 16V

24

BE505204

Silniki 1.4 - 1.6 - 1.8 - 2.0 - 2.2 - 2.5

25

KOMPLETNY ZESTAW NARZĘDZI PASUJĄCY DO FORD 1.25-1.4-1.6 BENZYNA



Kompletne zestawy

BE505101

Marka	Model	Silnik	Kod silnika
FORD	Fiesta, Focus, CMax, Mondeo, Fusion	1.25	F8JA, F8JB, FUJA, FUJB, M7JA, M7BJ, SNJA, SNJB, STJA, STJB
		1.4	ASDA, ASDB, FXDA/C, FXDB/D, FXJA, FXJB, FXJC, SPJA, SPJC
		1.6 16V	FYDA/C, FYDB/D, FYDH, FYJA, FYJB, FYJC, HWDA, HWDB, SHDA, SHDB, SHDC
		1.6	L1T, L1V, L1W
		1.6 SCTi Ecoboost	JQDA, JQDB, JTDA, JTDB
		1.6 Ti-VCT	HXDA, HXJA, HXJB, IQDA/B, IQDB, PNBA, PNDA, RHBA, SIDA

Składniki

NARZĘDZIE BLOKADY ROZRZĄDU	BE50510101	303-1097	
TRZPIEŃ BLOKADY NAPINACZA	BE50510102	303-1054 T10015	
NARZĘDZIE DO BE50510104	BE50510103	303-393-2	
NARZĘDZIE DO BLOKOWANIA KOŁA ZAMACHOWEGO	BE50510104	303-393 21-168 303-1272	
TRZPIEŃ DO WAŁU	BE50510105	303-748 21-226 21-259	
USTAWIENIE PASKA ROZRZĄDU	BE50510106	303-376 303-376B 21-162B 303-367	

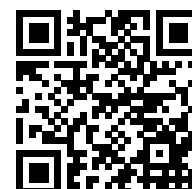

KOMPLETNY ZESTAW NARZĘDZI PASUJĄCY DO FORD 1.0 ECOBOOST PETROL



Kompletne zestawy

BE505102

Marka	Model	Silnik	Kod silnika	Rok
FORD	B-MAX	1.0 EcoBoost	SFJA	2012-2014
	B-MAX	1.0 EcoBoost	SFJB	2012-2014
	C-MAX	1.0 EcoBoost	M1DA	2012-2014
	C-MAX	1.0 EcoBoost	M2DA	2012-2014
	EcoSport	1.0 EcoBoost	M1JC	2012-2014
	EcoSport	1.0 EcoBoost	M1JC	2012-2014
	Fiesta	1.0 EcoBoost	M1JE	2012-2014
	Fiesta	1.0 EcoBoost	M1JE	2012-2014
	Fiesta	1.0 EcoBoost	SFJA	2012-2014
	Fiesta	1.0 EcoBoost	SFJB	2012-2014
	Focus	1.0 SCTi EcoBoost	M1DA	2012-2014
	Focus	1.0 SCTi EcoBoost	M2DA	2012-2014
	Grand C-MAX	1.0 EcoBoost	M1DA	2012-2014
Grand C-MAX	1.0 EcoBoost	M2DA	2012-2014	

Składniki

NARZĘDZIE BLOKADY ROZRZĄDU 1

BE50510201

303-1605/1

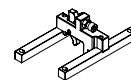

NARZĘDZIE BLOKADY ROZRZĄDU 2

BE50510202

303-1605/2

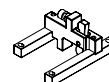

TRZPIEŃ DO WAŁU

BE50510203

303-1604



NARZĘDZIE DO BLOKOWANIA KOŁA
ZAMACHOWEGO

BE50510204

303-1602

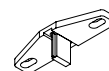

Składniki

NARZĘDZIE BLOKUJĄCE KOŁO ZĘBATE ROZRZĄDU	BE50420102	0194-A 11 9 790 21-260 303-732 999-7233 2000023000 2000023100	
TRZPIEŃ BLOKADY NAPINACZA	BE50510102	11 9 270	



KOMPLETNY ZESTAW NARZĘDZI PASUJĄCY DO FORD 2.0 - 2.2 - 2.4 DURATORQ TDCI 16V DIESEL

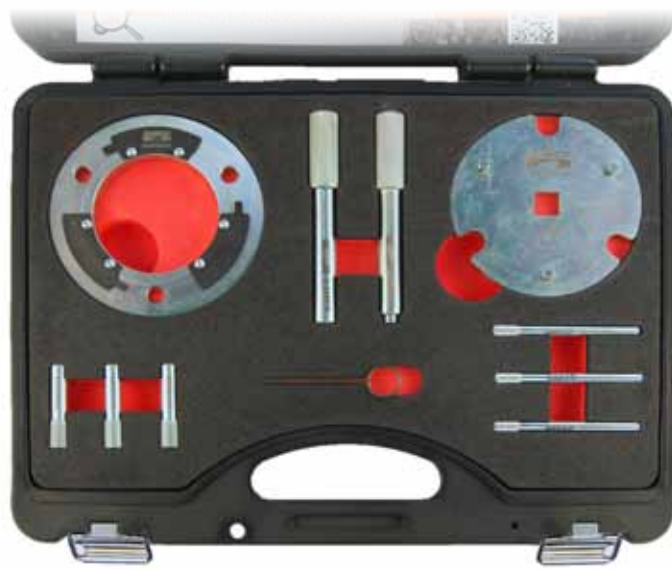

Kompletne zestawy

BE505203

Marka	Model	Silnik	Kod silnika
FORD DURATORQ	Focus C-Max, Focus S-Max, Mondeo, Nuova Focus, Transit, New Galaxy	2.0 TDCI 2.2 TDCI 2.4 TDCI	FMBA/B, D5BA, ABFA, D3FA, D6BA, HJBA/B, F3FA, D2FA, D4FA, F4FA, FIFA, DOFA, QJBA, QJBB, FXFA, H9FA, 244DT
JAGUAR	X-Type	2.0 D, 2.2 D	
LAND ROVER	Defender	2.4 TD4	

Składniki

NARZĘDZIE DO USUWANIA POKRYWY POMPY PALIWA	BE50520301	303-679A	
PRZYRZĄD DO BLOKOWANIA NAPINACZA	BE50520302	T40011	
TRZPIEŃ DO WAŁU	BE50520303	303-698	
NARZĘDZIE DO BLOKOWANIA KOŁA ZAMACHOWEGO	BE50520304	303-675	
TRZPIEŃ BLOKUJĄCY	BE50520305	/	
TRZPIEŃ BLOKUJĄCY	BE50520306	/	
NARZĘDZIE DO USTAWIANIA POMPY	BE50520307	303-1151	

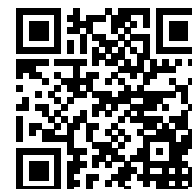

KOMPLETNY ZESTAW NARZĘDZI PASUJĄCY DO FORD 1.4-1.6-1.8- 2.0-2.2-2.5 DIESEL



Kompletne zestawy

BE505204

Marka	Model	Silnik	Kod silnika	Rok
FORD	Fiesta, Fusion, Focus, Focus C-Max, C-Max, B-Max; S-Max, Galaxy, Mondeo, Ecosport	1.4D TDCi	F6JA, F6JB, F6JC, F6JD	2002-2009 2004-2009 2003-2007 2007-2009
		1.5D TDCi	UGJC	
		1.6D TDCi	TZJA, TZJB, G8DA, G8DB, G8DC, G8DD, G8DE, G8DF, HHDA, HHDB, HHJA, HHJB, HHJC, HHJD, HHJE, HHJF	
		1.8D	RTA, RTB, RTC, RTD, RTG, RTE, RTF, RTH, RTJ, RTK	
		1.8D TCI	RFN	
		1.8D TDdi	BHPA, HCPA, HCPB, KKDA, P7PA, P9PA, P9PB, R2PA, R3PA, RWPA, RWPC, F9DA/B	
		1.8D TDCi	FFBA, FFWA, KHBA, QYBA, QYWA	
		1.8D TDCi	KKDB	
		1.8D Turbo	C9DC	
		1.8D Turbo	RVA	
		2.0D TDCi	G6DA, G6DB, G6DC, G6DD, G6DE, G6DF, G6DG, UFDB, TXDB, TYDA, UKDB, QXBA, QXBB, QXWA, QXWB, AZBA, KLBA, LPBA, AZBC, TYBA, UKBA, UFBA, TXBA, IXDA, QXWA, QXWB, AZWA, KLWA, AZWC, TYWA, UKWA, TXWA, UFWA, UFDA, TXDA, UKDA,	
		2.2 TDCi	Q4BA, KNBA, QXBA, QXWA, QXBB	
		2.5D	4BA, 4BB, 4BC 4CC, 4FA, 4CA, 4CB, 4DA, 4EA 4FA, 4FB, 4FC, 4FD, 4GA, 4HB, 4HC	
2.5D Turbo	4EB, 4EC, 4ED 4GA, 4GB, 4GC, 4GD, 4GE, 4GF, 4HA, 4HD			
VOLVO	S40 (03-10); S80 (07-10); V50 (06-10); V70 (07-10); C30 (06-10); C70 (06-10)	1.6D	D4164T	2003-2010
		2.0D	D420T	2006-2010 2007-2010
MAZDA	2, 3	1.4D TDCi	F6JA, F6JB	2002-2009
		1.6D 8V	MZ-CD 1.6	2004-2009
PEUGEOT	207	1.6 Hdi	DV6ATED4 (9HX)	2006-2010
	207		DV6TED4 (9HZ)	2006-2010
	207		DV6TED4 (9HY)	2006-2010
	207		DV6TED4 (9HV)	2007-2010
	207		DV6C (9HR)	2010-2013
	207		DV6D (9HP)	2010-2013









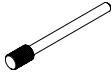
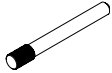
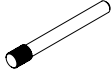
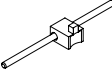

Dalsze

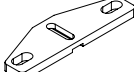
Marka	Model	Silnik	Kod silnika	Rok
PEUGEOT	207 CC	1.6 Hdi	DV6TED4 (9HZ)	2007-2010
	207 CC		DV6C (9HR)	2010-2014
	208		DV6C (9HR)	2012-2014

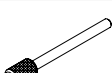
Pomocnicze narzędzia systemowe nie są przeznaczone do silników Peugeot-Citroën

Sprawdź wszystkie zastosowania w instrukcji obsługi

Składniki

TRZPIEŃ ROZRZĄDU/POMPY WTRYSKOWEJ	BE50520401	23-019	
TRZPIEŃ USTAWNY	BE50520402	21-123	
TRZPIEŃ POMPY WTRYSKOWEJ	BE50520403	23-029	
NARZĘDZIE DO NAPINANIA PASKA CAM	BE50520404	0118-J2	
TRZPIEŃ DO WAŁU	BE50520405	21-104; 303-193	
NARZĘDZIE DO BLOKOWANIA KOŁA ZAMACHOWEGO	BE50510104	303-393; 21-168; 303-1272	
NARZĘDZIE DO BE50510104	BE50520407	303-393-1	
NARZĘDZIE DO BLOKOWANIA KOŁA ZAMACHOWEGO	BE50420103	0194-C; 303-734; 21-262; 2000022500; 999-7169	
TRZPIEŃ ROZRZĄDU/POMPY WTRYSKOWEJ	BE50420102	0194-A; 11 9 790; 21-260; 303-732; 999-7233; 2000023000; 2000023100	
NARZĘDZIE DO USTAWIANIA WAŁU	BE50420104	0194-B; 11 9 790; 303-735; 21-263; 2000023200; 999-7122	
TRZPIEŃ NAPINAJĄCY KOŁO ZAMACHOWE	BE50520411	0188-X; 303-1059; 303-1270; 999-7121	
TRZPIEŃ USTAWNY	BE50520412	23-020	
TRZPIEŃ DO WAŁU	BE50520413	21-104; 303-193	
USTAWIENIE PASKA ROZRZĄDU	BE50510106	303-376; 303-376B; 21-162B; 303-367	





PEUGEOT / CITROËN

SILNIKI BENZYNOWE

BE504102

Silniki 1.4 - 1.6

28

BE507101

Silniki 1.0 - 1.4 - 1.6 - 1.8 - 2.0 - 2.2

29

BE507102

Silniki 1.0 - 1.2 VTi

31

SILNIKI DIESELA

BE507203

Silniki 1.4 - 1.5 - 1.6 - 1.9 - 2.0 - 2.5

32

KOMPLETNY ZESTAW NARZĘDZI PASUJĄCY DO MINI-PSA 1.4-1.6 BENZYNA

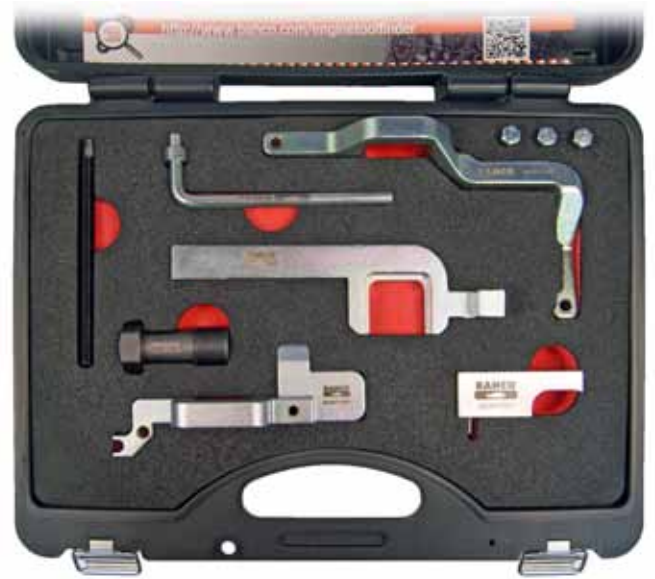

Kompletne zestawy

BE504102

Marka	Model	Silnik	Kod silnika
CITROËN	Berlingo 3, C3 3, C3 Picasso, C4 /C4 Picasso/ Grand Picasso, C4 2, C4 Picasso/Grand Picasso, C4/C4 Picasso/Grand Picasso, C5 3, DS3/DS3 Cabrio, DS4, DS5	1.4VTi (Valvetronic)	EP3(8FS)
		1.6VTi (Valvetronic)	EP6(5FW)
PEUGEOT	207, 208, 307, 308, 508, 2008, 3008, 5008, 207 CC, 308 CC, PARTNER 3, RCZ	1.6THP (direct ignition)	EP6DT(5FX), EP6DTS(5FY)
MINI	Mini (R56/57) One, Mini (R56/57) One/First, Mini (R56/57) Cooper, Mini (R56/57) Cooper S, Mini (R56/57) JCW, Mini Clubman (R55) One, Mini Clubman (R55) Cooper, Mini Clubman (R55) Cooper S, Mini Clubman (R55) JCW	1.4 - 1.6	N12, N14

Składniki

NARZĘDZIE DO USTAWIANIA ROZRZĄDU 1	BE50410201	11 9 540; 11 9 550 0197-A1	
NARZĘDZIE DO USTAWIANIA ROZRZĄDU 2	BE50410202	11 9 540; 0197-A3	
NARZĘDZIE DO USTAWIANIA ROZRZĄDU 3	BE50410203	11 9 550; 0197-A2	
TRZPIEŃ DO ROZRZĄDU	BE50410204	11 9 590; 0197-B	
NARZĘDZIE DO WSTĘPNEGO NACIĄGU ŁAŃCUCHA	BE50210105	11 9 340	
NARZĘDZIE DO USTAWIANIA ROZRZĄDU 4	BE50410206	11 9 550; 0197-A2	



KOMPLETNY ZESTAW NARZĘDZI PASUJĄCY DO PSA 1.0-1.1-1.4- 1.6-1.8-2.0-2.2 BENZYNA











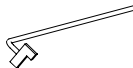







Kompletne zestawy

BE507101

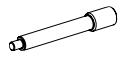
Marka	Model	Silnik	Kod silnika
CITROËN	Xsara, Picasso, C4, C5, C8, Jumpy, Dispatch		TU9M (CDY), TU9M (CDZ), TU1M (HDZ), TU3 (K1A), TU3, 2/K (K2D), TU3A (K1G), TU3ACLC (K1D), TU3ATN(K1G), TU3CP (KAY), TU3F2 (K2D), TU3FJ2 (K6B), TU3FJ2 (KFZ), TU3JP (KFW), TU3JP (KFX), TU3JP/IFL4 (KFX), TU3JP/L3 (KFX), TU3M (KDX), TU3M (KDY), TU3M (KDY/Z), TU3M (KDZ), TU3M/Z (KDX), TU3M/Z (KDY), TU3M/Z (KDZ), TU3MCZ (KDX), TU3S (K2B), TU3SCLC / K2B, TU5J2 (NFW), TU5J2 (NFY), TU5JP (NFT), TU5JP (NFZ), TU5JP/L3 (NFZ), TU5JP/Z 8 (NFZ), TU5J4 (NFU), TU5JP4 (NFU), TU5JP4B (NFR), XU5JA (B6E), XU5JP (BFZ), XU5M3/Z (BDY), XU5M3Z (BDY), XU7JP/L3 (LFX), EW7A (6FY), EW7J4 (6FZ), XU7JB (LFX), XU7JP (LFW), XU7JP/L3 (LFZ), XU7JP/Z (LFZ), XU7JP4 (LFY), XU7JP4/L3 (LFY), EW10A (RFJ), EW10J4 (RFN), EW10J4 (RFR), EW10J4S (RFK), XU102C/K (R2A), XU10J2C (RFX), XU10J2CL/Z (RFX), XU10J2K (R6A), XU10J2L/Z (RFZ), XU10J2U (RFL), XU10J2U/ X3 (RFX), XU10J2Z (RFZ), XU10MZ (RDZ), XU10J2C/Z (RFU), XU10J4R (RFV), XU10J4R/L3 (RFV), XU10J4L/Z (RFT), XU10J4L/Z (RFY), XU10J4R/L/Z (RFV), XU10J4Z (RFT), XU10J2CTE (RGX), XU10J2TE (RGY), XU10J2TE/Z (RGX), XU10J4TE/Z (RGZ), EW12J4 (3FY), EW12J4 (3FZ), K1F, K1G, K2A, K2B, K2D, K2D (TU3F2K), K3A, KDX (TU3FMC/LZ), KDX(TU3MC), KDY (TU3FM), KDY (TU3FM/L), KDY (TU3M/FM/L), KDZ (TU3M), KFX (TU3JP), KFX (TU3JP/IFL4), KFX (TU3JP/L3), KFX (TU3JP/L4), KFX (TU3JP+/ L3), KIG (TU3A), KJV (TU3A), KJV (TU3JP), KFW (TU3A), KFW (TU3JP/L4), NFZ (TU5JP), NFZ (TU5JP) BVA, NFT (TU5JP/L4), NFV (TU5JP/L4), NFZ (TU5JP), NFZ (TU5JP/L3), NFZ (TU5JP+), NFZ (TU5JP+/L3), B4A, B4A (XU5M3K), BFZ (XU5TP), BDY (XU5M3/L), B1F (XU51C), B2C (XU52C), BDZ (XU5M3/L), B6E (XU5JA), BFZ (XU5JP), B1A/A, NFR (TU5JP4B), NFU (TU5JP4), NFU (TU5JP4/L4), NFS (TU5JP4S), 6FY (EW7A), 6FZ (EW7J4), LFW (XU7JP/L3), LFX (XU7JB), LFX (XU7JB/L3), LFZ (XU7JP), LFZ (XU7JP/LZ), LFZ (XU7JP/Z), LFY (XU7JP4), RFJ (EW10A), R2A (XU102C), R6A (XU10J2), RDZ (TU10M), RFX (XU10J2C/LZ), RFX (XU10J2C/Z), RFZ (XU10J2), RGX (XU10J2E), RGX (XU10J2TE), RFL (XU10J2U), RFN (EW10J4), RFN (EW10J4/L5), RFU (XU10J2C), RFW (XU10J2U), RFN (EW10J4/L4/5), RFS (XU10J4RS), RFT (XU10J4D), RFV (XU10J4R), RFY (XU10J4/L-Z), RFY (XU10J4D/Z), RFS (XU10J4RS/L3), RFV (XU104R), 3FZ (EW12J4/L5)
PEUGEOT	206, 206CC, 307, 307CC, 406, 407, 607, 806, 807, Expert	1.0, 1.1, 1.4, 1.6, 1.6 16v, 1.6 GTi, 1.6 18v, 1.8, 1.8 16v, 1.9, 2.0, 2.0 16v, 2.0T, 2.0 HPi, 2.2 16v	

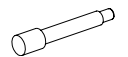
Składniki

NARZĘDZIE BLOKUJĄCE ROLKI NAPINACZA	BE50710101	0189-S2	
NARZĘDZIE DO BLOKOWANIA KOŁA ZAMACHOWEGO	BE50710102	0153-A; 6012-T; D.86; 9765,54	
TRZPIEŃ DO BLOKOWANIA KOŁA ZAMACHOWEGO	BE50710103	0189-C	
ZACISK MOCUJĄCY PASEK NAPINAJĄCY	BE50710104	0188-K; 0189-K; 0132-AK; 0153-AK; 4533-TAD	
NARZĘDZIE ROLKI NAPINACZA	BE50710105	0189-S1	
NARZĘDZIE DO BLOKOWANIA KOŁA ZAMACHOWEGO	BE50710106	0188-F; 0134-AF; 0134-Q	
TRZPIEŃ NAPINACZA PASKA CAM	BE50710107	4200-TH	
TRZPIEŃ DO WAŁU	BE50710108	4533-TAC2; 0132-AJ2	
TRZPIEŃ DO WAŁU	BE50710109	0189-A	
TRZPIEŃ WAŁU/KOŁA ZAMACHOWEGO	BE50710110	0132-Q; 4507-TA; 9767,27	
TRZPIEŃ DO WAŁU/ROZRZĄDU	BE50710111	4507-TB	
TRZPIENIE DO WAŁU	BE50710112	0153-AB; 9041-TZ	
TRZPIEŃ DO WAŁU/ROZRZĄDU	BE50710113	0188-M; 0189-J; 0132-AJ1; 0153-G; 4533-TAC1; 7014-TN; 9766,98	
TRZPIEŃ DO WAŁU WLOT	BE50710114	0189-L	
NARZĘDZIE DO USTAWIANIA WAŁU	BE50420104	0194-B; 11 9 790; 303-735; 21-263; 2000023200; 999-7122	
TRZPIENIE DO WAŁU	BE50710116	0153-M; 7014-TM; 9767,94	
TRZPIEŃ DO WAŁU	BE50710117	0189-AZ	
TRZPIEŃ DO WAŁU/ROZRZĄDU	BE50710118	7004-TG; 7018-TY; 0132-R	
NARZĘDZIE DO BLOKOWANIA KOŁA ZAMACHOWEGO	BE50710119	0189-R	

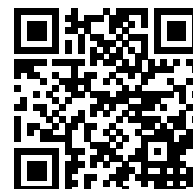

KOMPLETNY ZESTAW NARZĘDZI PASUJĄCY DO PSA 1.0-1.2 BENZYNA



Kompletne zestawy

BE507102

Marka	Model	Silnik	Kod silnika	Rok
PEUGEOT	208	1.0 VTi	EBO (ZMZ)	2012 - 2014
	208	1.2 VTi	EB2 (HMZ)	
	2008	1.2 VTi	EB2 (HMZ)	
CITROËN	C3 (III)	1.0 VTi	EBO (ZMZ)	
	DS3; DS3 Cabrio	1.2 VTi	EB2 (HMZ)	

Składniki

NARZĘDZIE DO USTAWIANIA ROZRZĄDU

BE50710201

0109-2A

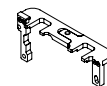

TRZPIEŃ NAPINAJĄCY KOŁO ZAMACHOWE

BE50710202

0109-2B

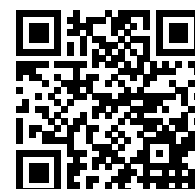

KOMPLETNY ZESTAW NARZĘDZI PASUJĄCY DO PSA 1.4-1.5-1.6- 1.9-2.0-2.2-2.5 DIESEL



Kompletne zestawy

BE507203

Marka	Model	Silnik	Kod silnika
CITROËN	Xsara, Xsara Picasso, C2, C3, C4, C5, C8, Xantia, Evasion, Evasion Synergie, Berlingo, Dispatch, Dispatch Jumpy, Relay, Relay Jumper	1.4D HDi	DV4TD (8HT), DV4TD (8HX), DV4TD (8HZ), DV4TED (8HS)
		1.5D	TUD5/L3, VJY (TUD5/Y), VJZ (TUD5/L/L3), VJZ (TUD5/L/Y/L3)
		1.6D HDi	DV6ATED4 (9HX), DV6BTED4 (9HT), DV6BTED4 (9HW), DV6TED4 (9HY), DV6TED4 (9HZ), DV6TED4B (9HV), DV6UTED4 (9HU)
		1.9D	DW8B/L4 (WJY)
		2.0D HDi	DW10ATED (RHS), DW10ATED (RHZ), DW10TD (RHY)
		2.0D HDi	DW10ATED4/L4 (RHT), DW10JATED4 (RHW)
		2.0D HDi	DW10BTED4 (RHF), DW10BTED4 (RHR)
		2.0D HDi	DW10ATED4 (RHW)
		2.0D HDi	DW10CTED4 (RHE), DW10CTED4 (RHH)
PEUGEOT	107, 206, 207, 306, 307, 308, 406, 406 Coupe, 407 607, 807, Expert, Partner, Boxer, Ranch	1.4D HDi	DV4TD (8HT), DV4TD (8HX), DV4TD (8HZ), DV4TED (8HS)
		1.5D	TUD5/L/Y/L3 (VJZ), TUD5/Y/L3 (VJZ), TUD5B (VJX)
		1.6D HDi	DV6ATED4 (9HX), DV6AUTED4 (9HX), DV6BTED4 (9HT), DV6BTED4 (9HW), DV6BUTED4 (9HT), DV6TED4 (9HV), DV6TED4 (9HW), DV6TED4 (9HX), DV6TED4 (9HY), DV6TED4 (9HZ), DV6TED4B (9HS), DV6TED4B (9HV), DV6UTED4 (9HU)
		1.9D	DW8 (WJY), DW8/L/W3 (WJZ), DW8/L3 (WJZ), DW8B/L4 (WJY)

Sprawdź wszystkie zastosowania w instrukcji obsługi

Składniki

TRZPIEŃ NAPINAJĄCY KOŁO ZAMACHOWE	BE50720301	4507-TL / 0132P	
TRZPIEŃ NAPINACZA	BE50720302	0188-Q2	
NARZĘDZIE DO NAPINANIA PASKA CAM	BE50520404	0118-J2	
NARZĘDZIE DO NAPĘDU NAPINACZA PASKA	BE50720304	4507-TJ; 0132-X; 0188-Q1; 9769,89	
DŹWIGNIA NAPINAJĄCA	BE50720305	0178-E	
TRZPIEŃ NAPINACZA PASKA CAM	BE50710107	4200-TH	
ŚCIAĞACZ KOŁA WAŁU	BE50720307	0188-P; 0188-P2	

Dalsze

Składniki

SPRĘŻYNA DO BE50520411	BE50720308	/	
ZACISK MOCUJĄCY PASEK NAPINAJĄCY	BE50710104	0188-K; 0189-K; 0132-AK; 0153-AK; 4533-TAD	
TRZPIEŃ BLOKUJĄCY POMPE	BE50720310	0188-H	
NARZĘDZIE DO BLOKOWANIA KOŁA ZAMACHOWEGO	BE50420103	0194-C; 303-734; 21-262; 2000022500; 999-7169	
TRZPIEŃ POMPY WTRYSKOWEJ	BE50720312	4527-TS1	
NARZĘDZIE BLOKUJĄCE KOŁO ZĘBATE ROZRZĄDU	BE50420102	0194-A; 11 9 790; 21-260; 303-732; 999-7233; 2000023000; 2000023100	
TRZPIEŃ BLOKADY WAŁU	BE50720314	4527-TS2	
TRZPIEŃ NAPINAJĄCY KOŁO ZAMACHOWE	BE50520411	0188-X; 303-1059; 303-1270; 999-7121	
TRZPIEŃ DO ROZRZĄDU/WAŁU	BE50710113	0188-M; 0189-J; 0132-AJ1; 0153-G; 4533-TAC1; 7014-TN; 9766,98	
TRZPIEŃ DO ROZRZĄDU/WAŁU	BE50720317	0189-B	
TRZPIEŃ USTAWNY	BE50720318	0178-B; 5711-TB	
TRZPIEŃ NAPINAJĄCY KOŁO ZAMACHOWE	BE50720319	0153-U; 7019-T	
TRZPIEŃ USTAWNY ZAGIĘTY	BE50720320	0188-D; 7017-TR	
TRZPIEŃ NAPINAJĄCY KOŁO ZAMACHOWE	BE50720321	0188-Y; 0153-N; 7099-TM; 7014-TJ; 9767,34	
NARZĘDZIE DO NAPINANIA PASKA CAM	BE50720322	0188-J1	
ŚRUBA M8	BE50720323	0188-E	
NARZĘDZIE DO BLOKOWANIA KOŁA ZAMACHOWEGO	BE50710102	0153-A; 6012-T; D.86; 9765,54	
NARZĘDZIE DO BLOKOWANIA KOŁA ZAMACHOWEGO	BE50710106	0188-F; 0134-AF; 0134-Q	
TRZPIEŃ WAŁU/KOŁA ZAMACHOWEGO	BE50710110	0132-Q; 4507-TA; 9767,27	

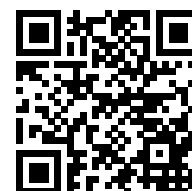



RENAULT / NISSAN

SILNIKI BENZYNOWE

BE508101

Silniki 1.2 - 1.4 - 1.6 - 1.8 - 2.0

35

SILNIKI DIESELA

BE508202

Silniki 1.5 - 1.9 - 2.2 - 2.5

37

BE508203

Silniki 2.0

39

BE508204

Silniki 1.6 dCi

40

KOMPLETNY ZESTAW NARZĘDZI PASUJĄCY DO RENAULT/DACIA 1.2-1.4-1.6-1.8-2.0 BENZYNA

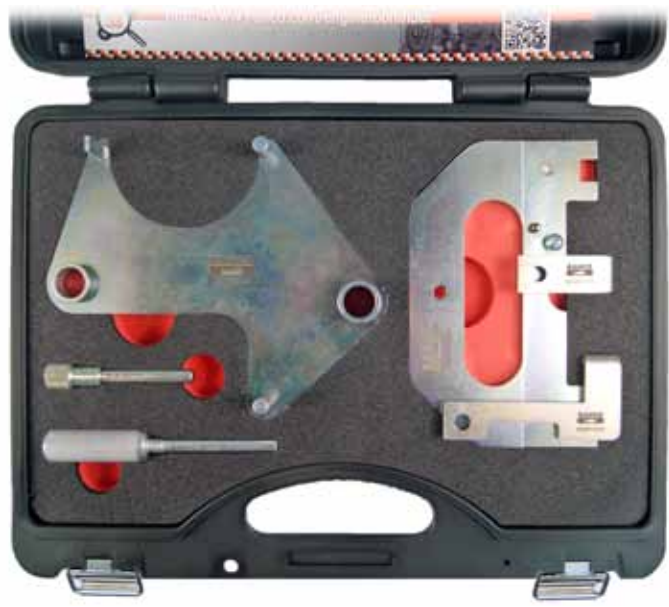

Kompletne zestawy

BE508101

Marka	Model	Silnik	Kod silnika
Renault	Clio; Clio sport; Megane; Megane Scénic; Scénic; Laguna; Espace; Grand Espace; Twingo; Kangoo; Thalia; Modus; Trafic; Logan; Wind	1.2 16V	D4F 702, D4F 704, D4F 706, D4F 708, D4F 712, D4F 714, D4F 716, D4F 722, D4F 728, D4F 730, D4Ft 782
		1.4	K4J 730, K4J 732, K4J 740, K4J 780
		1.4	K4J 714, K4J 750, K4J 770, K4J 780
		1.4	K7J 710
		1.4 16V	K4J 700, K4J 710, K4J 711, K4J 712, K4J 713, K4J 715
Dacia	Logan, Sandero	1.6	K4M 710, K4M 711, K4M 714, K4M 716, K4M 718, K4M 760, K4M 761, K4M 766, K4M 782, K4M 800, K4M 801, K4M 824, K4M 848, K4M 854, K4M 858, K4M 700, K4M 708, K4M 720/4, K4M 730, K4M 732, K4M 734, K4M 740, K4M 742, K4M 743, K4M 744, K4M 745, K4M 746, K4M 748, K4M 752, K4M 753
Renault	Clio; Clio sport; Megane; Megane Scénic; Scénic; Laguna; Espace; Grand Espace; Twingo; Kangoo; Thalia; Modus; Trafic; Logan; Wind	1.6	K4M 790, K4M 791, K4M 792, K4M 794, K4M 802, K4M 804, K4M 812, K4M 813
		1.6	K7M 710, K7M 744, K7M 745, K7M 850
		1.8	F4P 720, F4P 722, F4P 770, F4P 771, F4P 772, F4P 773, F4P 774, F4P 775
		2.0	F3R 751, F3R 750, F3R 791, F3R 796, F3R 797, F3R 798
		2.0	F4R 712, F4R 713, F4R 714, F4R 715, F4R 720, F4R 721, F4R 730, F4R 732, F4R 744, F4R 770, F4R 771, F4R 790, F4R 791, F4R 792, F4R 820, F4R 830, F4RT 774, F4RT 776, F4RT 794, F4RT 795, F4RT 796, F4RT 797, F4RT 870, F4RT 874
		2.0 16 V	F4R 740, F4R 741
		2.0 IDE	F5R 700, F5R 701
		2.0 Turbo	F4RT 764, F4RT 765, F4RT 786, F4RT 787, F4RT 810, F4RT 811
Dacia	Logan, Sandero	2.0 16 V	F4R 740, F4R 741
		2.0 IDE	F5R 700, F5R 701
		2.0 Turbo	F4RT 764, F4RT 765, F4RT 786, F4RT 787, F4RT 810, F4RT 811

Składniki

USTAWIENIE PASKA ROZRZĄDU

BE50810101

MOT 1496

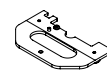

USTAWIENIE PASKA ROZRZĄDU

BE50810102

MOT 1496





TRZPIEŃ DO WAŁU

BE50810103

MOT 1054

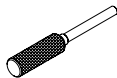

Składniki

TRZPIEŃ DO WAŁU	BE50810104	MOT 1489	
NARZĘDZIE KOŁA ZĘBATEGO ROZRZĄDU	BE50810105	MOT 1490-01	
USTAWIENIE PASKA ROZRZĄDU	BE50810106	MOT 1750	

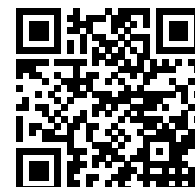

KOMPLETNY ZESTAW NARZĘDZI PASUJĄCY DO RENAULT 1.5-1.9-2.2-2.5 DIESEL









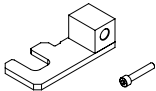
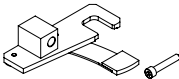

Kompletne zestawy

BE508202

Marka	Model	Silnik	Kod silnika
Renault	Clio, Kangoo, Laguna, Espace, Master, Mégane/Scénic, Trafic, Thalia, Modus, Twingo, Be Bop, Fluence, Logan	1.5D dCi	K9K 700, K9K 702, K9K 704, K9K 706, K9K 710, K9K 712, K9K 714, K9K 716, K9K 718, K9K 722, K9K 724, K9K 728, K9K 729, K9K 732, K9K 734, K9K 750, K9K 752, K9K 760, K9K 762, K9K 764, K9K 766, K9K 768, K9K 790, K9K 792, K9K 830, K9K 832, K9K 834, K9K 836, K9K 837, K9K 846
		1.9D dCi	F9Q 650, F9Q 660, F9Q 664, F9Q 670, F9Q 674, F9Q 680, F9Q 690, F9Q 740, F9Q 746, F9Q 748, F9Q 750, F9Q 751, F9Q 752, F9Q 754, F9Q 755, F9Q 758, F9Q 759, F9Q 772, F9Q 774, F9Q 800, F9Q 803, F9Q 804, F9Q 808, F9Q 812, F9Q 814, F9Q 818, F9Q 820, F9Q 826
		1.9D dTi	F9Q 770, F9Q 790, F9Q 870, F9Q 872, F9Q 780, F9Q 782
		1.9D dTi	F9Q 730, F9Q 734
		2.2D dCi	G9T 600, G9T 605, G9T 606, G9T 607, G9T 642, G9T 700, G9T 702, G9T 703, G9T 704, G9T 706, G9T 707, G9T 720, G9T 722, G9T 750, G9T 742, G9T 743
		2.5D dCi	G9U 630, G9U 632, G9U 650, G9U 720, G9U 724, G9U 726, G9U 730, G9U 750, G9U 754
Nissan	Kubistar, Interstar, Qashqai, Micra	1.5D dCi	K9K, K9K 702, K9K 704, K9K 710, K9K 714, K9K 718
		1.9D dCi	F9Q, F9Q 760, F9Q 762, F9Q 772, F9Q 774
		2.5D dCi	G9U 630, G9U 730
Opel	Vivaro, Movano	1.9D CDTi	F9Q 760, F9Q 762, F9Q 774
		2.2D DTi	G9T 720, G9T 750
		2.5D CDTi	G9U 630, G9U 632, G9U 650, G9U 724, G9U 726, G9U 730, G9U 750, G9U 754

Składniki

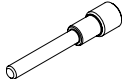
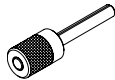
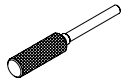
NARZĘDZIE BLOKADY ROZRZĄDU WLOT	BE5082021	MOT 1534 KM-6205	
NARZĘDZIE BLOKADY ROZRZĄDU UKŁAD WYDECHOWY	BE5082022	MOT 1537 KM-6204	
NARZĘDZIE POMPY WTRYSKOWEJ	BE5082023	MOT 1200-01	
NARZĘDZIE NACIĄGU	BE5082024	MOT 1543 KM-6234 KV113B0360	
TULEJA Ø 34 DO BE50820204	BE5082025	MOT 1543 KM-6234 KV113B0360	
TULEJA Ø 46,7 DO BE50820204	BE5082026	MOT 1543 KM-6234 KV113B0360	
TULEJA Ø 48 DO BE50820204	BE5082027	MOT 1543 KM-6234 KV113B0360	
TULEJA Ø 55 DO BE50820204	BE5082028	MOT 1543 KM-6234 KV113B0360	
TRZPIEŃ BLOKADY WAŁU	BE5082029	MOT 1536 KM-6203	
TRZPIEŃ DO WAŁU	BE50810103	MOT 1054 KM-6031 KV113B0280	
TRZPIEŃ DO WAŁU	BE50820211	MOT 1430 KV113B0110	
TRZPIEŃ DO WAŁU	BE50810104	MOT 1489 KV113B0130	

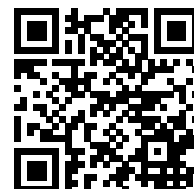

KOMPLETNY ZESTAW NARZĘDZI PASUJĄCY DO RENAULT 2.0 DIESEL



Kompletne zestawy

BE508203

Marka	Model	Silnik	Kod silnika	Rok
RENAULT	Megane II	2.0 dCi	Wszystkie silniki M9R	2002 - 2007
	Scenic II (08) / Grand Scenic			2008
	Laguna II - III (05-09)			2005 - 2009
	Espace (08) / Grand Espace	2008		
	Koleos (08)	2008		
	Trafic II (07-08)	2007 - 2008		
	Vel Satis	-		
Latitude	-			
NISSAN	Quashquai (08)	2.0 dCi	2008	
	X-Trail (07-08)	2007 - 2008		
	Primastar (08)	2008		
OPEL	Vivaro	2.0 CDTi	-	

Składniki

NARZĘDZIE DO USTAWIANIA ROZRZĄDU	BE50820301	MOT 1769 EN-48332	
NARZĘDZIE DO PODTRZYMYWANIA WAŁU	BE50820302	MOT 1770 EN-48334	
TRZPIEŃ DO WAŁU	BE50820303	MOT 1776 EN-48330	
NARZĘDZIE DO BLOKOWANIA KOŁA ZAMACHOWEGO	BE50820304	MOT 1431	
TRZPIEŃ DO WAŁU	BE50210305	EN-6130 11 3 340	

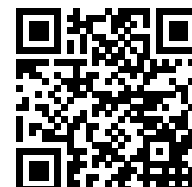

KOMPLETNY ZESTAW NARZĘDZI PASUJĄCY DO RENAULT-NISSAN 1.6 DIESEL



Kompletne zestawy

BE508204

Marka	Model	Silnik	Kod silnika
Nissan	Qashqai & Qashqai+2	1.6 dCi	Wszystkie silniki R9M
Renault	Megane, Scenic, Grand Scenic		

Składniki

NARZĘDZIE DO PODTRZYMYWANIA WAŁU	BE50820302	MOT 1770 EN-48334	
NARZĘDZIE DO USTAWIANIA ROZRZĄDU	BE50820402	MOT 1969	
TRZPIEŃ DO WAŁU	BE50820403	MOT 1970	
NARZĘDZIE PRZEKŁADNI ROZRZĄDU	BE50820404	MOT 1773	

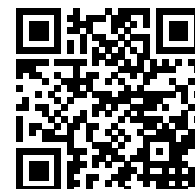



SAAB

SILNIKI BENZYNOWE

BE511101

1.8i

42

BE511102

1.6T

44

SILNIKI DIESELA

BE511203

1.9 - 2.0 - 2.2 TID

45

KOMPLETNY ZESTAW NARZĘDZI PASUJĄCY DO SAAB 1.8I BENZYNA



Kompletne zestawy

BE511101

Marka	Model	Silnik	Kod silnika	Rok
SAAB	9-3	1.8	Z18XE	2003-2010
	Astra	2.0	Z20LER	2006-2009
		1.4	X14XE	1995-1998
		1.6	X16XEL	1994-1998
		1.8	C18XEL	1994-1998
		1.8	X18XE	1996-1998
		2.0	X20XEV	1994-1995
		2.0	X20XEV	1995-1998
	Astra-F	1.4	X14XE	1998-2000
		1.4	Z14XE	2000-2005
		1.6	X16XEL	1998-2000
		1.6	Y16XE	2000-2005
		1.6	Z16XE	2000-2006
		1.6	Z16YNG	2002-2005
		1.8	X18XE1	1998-2000
		1.8	Z18XE	2000-2006
		1.8	Z18XEL	2000-2006
		1.8	Z18XE	2002-2005
		2.0	X20XEV	1998-2000
		2.0	Z20LET	2000-2001
		2.0	Z20LET	2002-2006
		2.0	Z20LET	2002-2006
		Astra-G	1.8	Z18XE
	2.0		Z20LEH	2005-2011
	2.0		Z20LEL	2004-2011
	2.0		Z20LER	2004-2011
	Calibra	2.0	X20XEV	1994-1996
2.0		X20XEV	1996-1998	
Cavalier	2.0	X20XEV	1993-1995	
Combo-C	1.6	Z16YNG	2007-2012	
	1.6	Z16YNG	2005-2008	

OPEL/VAUXHALL

Marka	Model	Silnik	Kod silnika	Rok
OPEL/VAUXHALL	Combo-C	1.6	Z16YNG	2009-2012
	Corsa-B	1.4	X14XE	1994-2000
		1.6	X16XE	1994-2000
	Corsa-C	1.4	Z14XE	2000-2007
		1.6	Z16YNG	2005-2007
		1.8	Z18XE	2000-2007
	Meriva-A	1.6	Z16XE	2003-2010
		1.8	Z18XE	2003-2010
	Omega-B	2.0	X20XEV	1994-1996
		2.0	X20XEV	1996-2000
		2.2	Y22XE	1999-2000
		2.2	Z22XE	2000-2003
	Signum	1.8	Z18XE	2003-2007
	Sintra	2.2	X22XE	1996-1999
	Tigra	1.4	X14XE	1995-2000
		1.6	X16XE	1995-2000
	Tigra-B	1.8	Z18XE	2004-2010
	Vectra-A	2.0	X20XEV	1993-1995
	Vectra-B	1.6	X16SEJ	1996-1998
		1.6	X16XEL	1995-2000
1.6		Y16XE	1999-2002	
1.6		Z16XE	2000-2002	
1.8		X18XE	1995-2000	
1.8		X18XE1	1998-2000	
1.8		Z18XE	2000-2002	
1.8		Z18XEL	2000-2002	
2.0		C20SEL	1997-2001	
2.0		X20XEV	1995-2000	

Sprawdź wszystkie zastosowania w instrukcji obsługi

Składniki

NARZĘDZIE BLOKADY ROZRZĄDU 1

BE51110101

KM-853



NARZĘDZIE BLOKADY ROZRZĄDU 2

BE51110102

KM-852



NARZĘDZIE DO BLOKOWANIA KOŁA ZAMACHOWEGO

BE50610204

KM-911

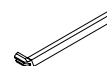

NARZĘDZIE NAPINACZA PASKA

BE50610201

KM-6130
EN-6349

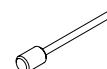

KOMPLETNY ZESTAW NARZĘDZI PASUJĄCY DO SAAB 1.6T BENZYNA

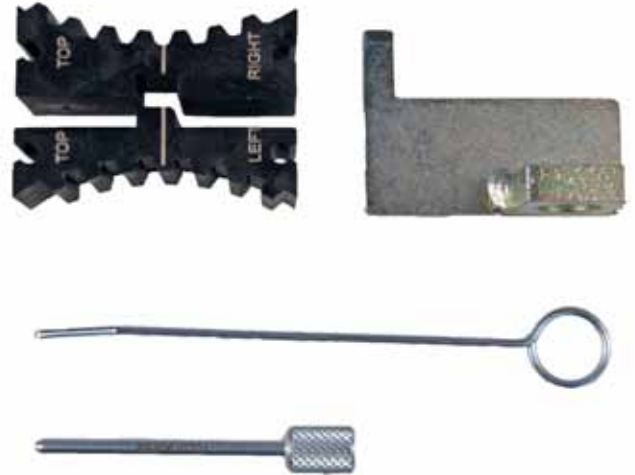

Kompletne zestawy

BE511102

Marka	Model	Silnik	Kod silnika	Rok
SAAB	9-5	1.6 T	LLU/A16LET	2010-2012
OPEL/VAUXHALL	Insignia	1.6	LLU/A16LET	2008-2013
	Astra-J	1.6	LLU/A16LET	2009-2014
	Corsa-D	1.6 Sri/Turbo	A16LEL	2009-2014
	Corsa-D	1.6 Turbo OPC/VXR	A16LER	2009-2014

Składniki

NARZĘDZIE NAPINACZA PASKA	BE50610201	KM-6130 EN-6349	
NARZĘDZIE DO USTAWIANIA ROZRZĄDU	BE50610202	KM-6340 2 000 012 100	
NARZĘDZIE DO BLOKOWANIA KOŁA ZAMACHOWEGO	BE50610203	KM-6625 2 000 012 800	
TRZPIEŃ BLOKADY NAPINACZA	BE50610205	KM-6333	



KOMPLETNY ZESTAW NARZĘDZI PASUJĄCY DO SAAB 1.9 - 2.0 - 2.2 TID DIESEL



Kompletne zestawy

BE511203

Marka	Model	Silnik	Kod silnika	Rok	
SAAB	9-3	1.9TiD	Z19DT	2004-2010	
		1.9TiD	Z19DTH	2004-2010	
		1.9TTiD	A19DTR	2010-2012	
		1.9TTiD	Z19DTR	2007-2010	
		1.9X TTiD	A19DTR	2010-2012	
		1.9X TTiD	Z19DTR	2009-2010	
		1.9TiD	Z19DTH	2005-2010	
		2.2TiD	D223L	2002-2004	
		2.2TiD	D223L	1998-2002	
		2.2TiD	D223L	2001-2002	
SAAB	9-5	2.2TiD	D223L	2002-2006	
		2.0TiD	LBS/A20DTH	2010-2012	
		2.0TTiD	LBY/A20DTR	2010-2012	
	OPEL/VAUXHALL	Astra	2.0CDTi	LBS/A20DTH	2012-2013
		Astra-G	2.0DTi	X20DTL	1998-2000
			2.0DTi	Y20DTH	1999-2005
		Astra-H	1.9CDTi	Z19DT	2004-2011
			1.9CDTi	Z19DTH	2004-2011
			1.9CDTi	Z19DTJ	2005-2011
			1.9CDTi	Z19DTL	2006-2011
Astra-J		2.0CDTi	LBS/A20DTH	2009-2012	
		2.0CDTi	LBS/A20DTH	2011-2014	
		2.0CDTi ecoFLEX	LBS/A20DTH	2011-2012	
	2.0CDTi ecoFLEX	LBS/A20DTH	2011-2014		
	2.0CDTi	LBS/A20DTH	2009-2012		
	2.0CDTi	LBS/A20DTH	2011-2014		
	2.0CDTi	LBX/A20DTJ	2012-2014		
	2.0CDTi ecoFLEX	LBS/A20DTH	2011-2012		
	2.0CDTi ecoFLEX	LBS/A20DTH	2011-2014		
	2.0Bi-CDTi	LBX/A20DTR	2011-2014		
Insignia	2.0Bi-CDTi ecoFLEX	LBX/A20DTR	2011-2014		
	2.0CDTi	LBS/A20DTH	2008-2013		

Dalsze

Marka	Model	Silnik	Kod silnika	Rok
OPEL/VAUXHALL	Insignia	2.0CDTi	LBV/A20DTR	2008-2012
		2.0CDTi ecoFLEX	LBS/A20DTH	2009-2013
		2.0CDTi ecoFLEX	LBS/A20DTH	2009-2014
		2.0Bi-CDTi	LBV/A20DTR	2011-2014
		2.0Bi-CDTi ecoFLEX	LBV/A20DTR	2011-2014
		2.0CDTi	LBQ/A20DTL	2010-2013
		2.0CDTi	LBR/A20DT	2010-2014
		2.0CDTi	LBS/A20DTH	2008-2013
		2.0CDTi	LBX/A20DTJ	2008-2012
		2.0CDTi	LBV/A20DTR	2008-2012
		2.0CDTi ecoFLEX	LBQ/A20DTL	2011-2013
		2.0CDTi ecoFLEX	LBS/A20DTH	2009-2013
		2.0CDTi ecoFLEX	LBS/A20DTH	2009-2014
		2.0CDTi	LCD/A20DTC	2008-2012
	Signum	1.9CDTi	Z19DT	2004-2008
		1.9CDTi	Z19DTH	2004-2008
		1.9CDTi	Z19DTL	2005-2008

Sprawdź wszystkie zastosowania w instrukcji obsługi

Składniki

NARZĘDZIE KOŁA ZĘBATEGO ROZRZĄDU	BE51120301	KM-933	
TRZPIEŃ BLOKUJACY POMPY WTRYSKOWEJ	BE51120302	KM-927	
TRZPIEŃ BLOKADY WAŁU	BE51120303	KM-929	
NARZĘDZIE BLOKADY ROZRZĄDU	BE51120304	KM-932	
TRZPIEŃ BLOKADY ROZRZĄDU	BE50120302	1 870 896 900 EN-46789	
NARZĘDZIE BLOKADY WAŁU	BE50120303	2 000 003 000	
NARZĘDZIE DO USTAWIANIA WAŁU	BE50110103	2 000 004 500	
NARZĘDZIE PODTRZYMUJĄCE ROZRZĄD	BE51120305	KM-933	
NARZĘDZIE NAPINACZA PASKA	BE50610201	KM-6130 EN-6349	

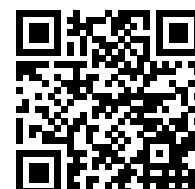
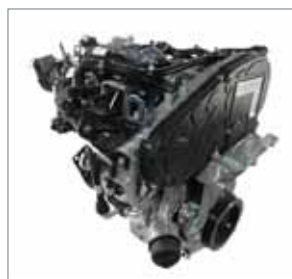



VAUXHALL / GM / OPEL / CHEVROLET

SILNIKI BENZYNOWE

BE506101

Silniki 1.0 - 1.2 - 1.4

48

BE506102

Silniki 1.4 - 1.6 - 1.8

49

BE506103

Silniki 1.0 - 1.2 - 1.4 ecoFLEX

50

SILNIKI DIESELA

BE506204

Silniki 2.0

51

KOMPLETNY ZESTAW NARZĘDZI PASUJĄCY DO OPEL 1.0-1.2-1.4 BENZYNA



Kompletne zestawy

BE506101

Marka	Model	Silnik	Kod silnika
OPEL	Corsa, Agila, Astra, Meriva	1.0 12V. 1.0 16V. 1.2 16V.	X10XE, Z10XE, Z10XEP, X12XE, Z12XE, Z14XEP, Z12XEP, Z14XEL
SUZUKI	Wagon R+	1.4 16V. (łańcuch)	

Składniki

NARZĘDZIE PÓŁOKRĄGŁE BLOKADY ROZRZĄDU

BE50610101

KM-954

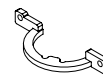

NARZĘDZIE BLOKADY ROZRZĄDU

BE50610102

**KM-953
KM-953-A**



TRZPIEŃ BLOKADY WAŁU

BE50610103

KM-952



TRZPIEŃ BLOKUJĄCY NAPINACZ ŁAŃCUCHA

BE50610104

KM-955-2

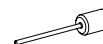

TRZPIEŃ BLOKUJĄCY NAPINACZ ŁAŃCUCHA

BE50610105

KM-955-1

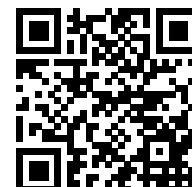

KOMPLETNY ZESTAW NARZĘDZI PASUJĄCY DO OPEL 1.4-1.6-1.8 BENZYNA



Kompletne zestawy

BE506102

Marka	Model	Silnik	Kod silnika	Rok
ALFA ROMEO	159	1.8	939A4.000	2005 - 2010
CHEVROLET	Aveo, Cruze, Orlando	1.4	G14D, LDD	2008 - 2011
		1.6	LXV (F16D4), LDE (F16D4)	2009 - 2012
		1.8	2HO(Z18XER)	2011 - 2012
FIAT	Croma	1.8	939A4.000	2006 - 2011
VAUXHALL, OPEL	Corsa, Agila, Astra-G, Astra-H, Meriva-A, Zafira-B, Vectra-C, Signum, Insigna	1.6	Z16LEL, Z16LER, Z16LET, Z16XE1, Z16XEP, Z16XER, A16XER, LGE/A16XNT	2007 - 2012; 2003 - 2006; 2004 - 2012; 2006 - 2010; 2001 - 2012; 2006 - 2008;
		1.8	Z18XER, A18XER, 2HO/A18XEL	2006 - 2008; 2008 - 2011

Składniki

NARZĘDZIE NAPINACZA PASKA	BE50610201	KM-6130 EN-6349	
NARZĘDZIE DO USTAWIANIA ROZRZĄDU	BE50610202	KM-6340 2 000 012 100	
NARZĘDZIE DO BLOKOWANIA KOŁA ZAMACHOWEGO	BE50610203	KM-6625 2 000 012 800	
NARZĘDZIE DO BLOKOWANIA KOŁA ZAMACHOWEGO	BE50610204	KM-911	
TRZPIEŃ BLOKADY NAPINACZA	BE50610205	KM-6333	
NARZĘDZIE BLOKADY ROZRZĄDU	BE50610206	KM-6628-A 2 000 012 000	

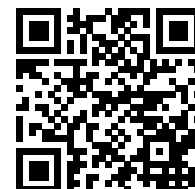

KOMPLETNY ZESTAW NARZĘDZI PASUJĄCY DO OPEL 1.0-1.2-1.4 ECOFLEX BENZYNA



Kompletne zestawy

BE506103

Marka	Model	Silnik	Kod silnika
OPEL	Corsa-D	1.0	A10XEP, A12XEL, A12XER, LUJ/A14NET, LUJ/A14NEL, LUH/A14NEL, LDD/A14XER, LDD/A14XEL
	Corsa-D; Adam	1.2	
	Astra-J; Zafira-C; Cascada; Insignia; Meriva-B; Mokka; Adam	1.4	
CHEVROLET	Aveo	1.2, 1.4	LWD/A12XEL, LDC/A12XER, L2Q/A12XEL, LDD/A14XER, LDD/A14XEL

Składniki

NARZĘDZIE BLOKADY ROZRZĄDU

BE50610102

**KM-953
KM-953-A**



NARZĘDZIE SENSORA ROZRZĄDU

BE50610302

EN-49977-100



TRZPIEŃ BLOKADY WAŁU

BE50610103

KM-952



NARZĘDZIE DO USTAWIANIA ROZRZĄDU

BE50610304

EN-49977-200



TRZPIEŃ BLOKUJĄCY NAPINACZ ŁAŃCUCHA

BE50610105

KM-955-1

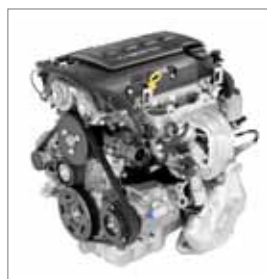

KOMPLETNY ZESTAW NARZĘDZI PASUJĄCY DO OPEL 2.0 DIESEL



Kompletne zestawy

BE506204

Marka	Model	Silnik	Kod silnika	Rok
OPEL	Antara	2.0 CDTi	Z20DM, Z20DMH	2006-10
CHEVROLET	Lacetti	2.0 CVCDi	Z20DM	2007-10
	Nubiria	2.0 CVCDi	Z20DM	2007-10
	Captiva	2.0 CVCDi	Z20S1	2007-11
	Epica	2.0 CVCDi	RA420/Z20S1	2006-11
	Cruze	2.0 CVCDi	LLW/Z20DMH	2009-11

Składniki

TRZPIEŃ BLOKADY WAŁU

BE50620401

EN-48246

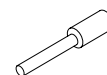

NARZĘDZIE BLOKADY ROZRZĄDU

BE50620402

EN-48245

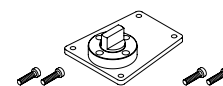

NARZĘDZIE DO NAPINACZA PASKA 2

BE50620403

EN-48253



TRZPIEŃ NAPINACZA PASKA NAPĘDOWEGO

BE50620404

EN-48952



NARZĘDZIE DO NAPINACZA PASKA 1

BE50620405

EN-48300



VOLKSWAGEN / AUDI / SEAT / ŠKODA

SILNIKI BENZYNOWE

BE509101

Silniki 1.4 - 1.6 - 1.8 - 2.0

53

BE509102

Silniki 1.2 - 1.4 - 1.6

55

BE509103

Silniki 1.2 TSi

57

BE509104

Silniki 1.0

58

SILNIKI DIESELA

BE509205

Silniki 1.2 - 1.4 - 1.6 - 1.9 - 2.0

60

BE509206

Silniki 1.9 - 2.0

62

BE509207

Silniki 1.2 - 1.4 - 1.6 - 1.9 - 2.0

63

KOMPLETNY ZESTAW NARZĘDZI PASUJĄCY DO GRUPY VW 1.4-1.6- 1.8-2.0 BENZYNA

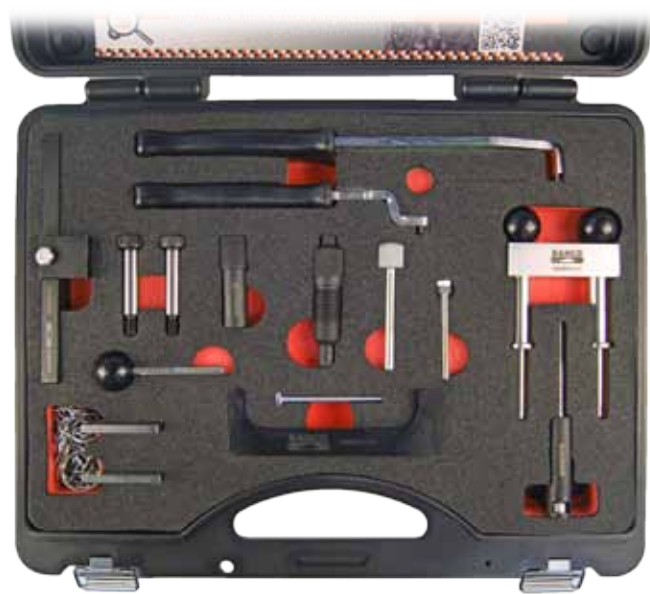

Kompletne zestawy

BE509101

Marka	Model	Silnik	Kod silnika
VW	Polo, Polo/Classic, Beetle, Caddy, Lupo, Golf, Golf Estate, Golf Plus, Bora, Passat, Vento, Jetta, Eos, Touran, Sharan, Transporter	1.4 16V	AFK, AHW, AKQ, APE, AQQ, AUA, AUB, BBY, BCA, AXP, BBZ, BKY
		1.4 FSI	ARR
		1.6	ADP, AEK, AFT, AHL, AKS, ALZ, ANA, ARM
		1.6	AEH, AKL, APF, AUR, AVU, AYD, BFQ, BFS
		1.6 16V	AJV, ARC, ATN, AUS, AVS, AVY, AZD, BCB
		1.6 FSI	BAD
		1.8	ADR, AGN, APT, ARG
		1.8 16V	KR, PD, PL
		1.8 Turbo	AEB, AGU, AJH, ANB, APU, AQA, ARZ, AUM, AUQ, AVC, AWU
		2.0	AAC, ABF, ADY, AKT, ATU, AWF, AWG, AZM
		2.0	APK, APQ, AQY, ATM, AZG, AZH, AZJ, BEH, ALT
		2.0 FSI	AXW
AUDI	80, A2, A3, S3, A4, A6, TT	1.4 FSI	AUA, BBY
		1.6	AEH, AKL, APF, AVU, BFQ, BGU, BSE, BSF, AHL, ALZ, ANA, ARM
		1.6 FSI	BAD
		1.8	ADR, AGN, AJL, AJP, AJQ, AMU, APG, APT, APX, ARG, AVV, BAM, BFV, BVP, BVR
		1.8 Turbo	AEB, AGU, AMK, ANB, APP, APU, APY, AQA, ARX, ARY, ARZ, AUM, AUQ, AWT
		2.0	ALT
		2.0 FSI	AXW, BMB, BLX, BLY, BLR, BVY, BVZ
		2.0 TFSI	BGB, BPG, BPJ, BPY, BUL, BWE, BWT, BYK
SEAT	Altea, Altea XI, Arosa, Ibiza, Cordoba, Inca, Leon, Toledo, Alhambra	1.4 16V	AXP, BBZ
		1.6	1F
		1.6	BGU, BSE, BSF
		1.8	AGN, AJQ, AMK, ANB, APG, APP, APT, APY, AQX, ARY, AUQ, AWC, AYP, BAM

Dalsze

Marka	Model	Silnik	Kod silnika
ŠKODA	Altea, Altea XI, Arosa, Ibiza, Cordoba, Inca, Leon, Toledo, Alhambra	1.8 Turbo	AJH
		2.0	ATM
		2.0 TFSI	BWA1
	Fabia, Octavia, Octavia II, Superb	1.4 16V	AXP, BBZ
		1.6	BGU, BSE, BSF
		1.8	AGN, AGU, ARZ, AUM, AUQ

Składniki

NARZĘDZIE BLOKADY ROZRZĄDU	BE50910101	T10016 T10074	
NARZĘDZIE DO USTAWIANIA ROZRZĄDU	BE50910102	3458	
TRZPIEŃ ROZRZĄDU/POMPY WTRYSKOWEJ	BE50910103	3359	
UCHWYT BLOKUJĄCY ROZRZĄD	BE50910104	2065A	
TRZPIEŃ BLOKADY WAŁU	BE50910105	3242	
USTAWIENIE PASKA ROZRZĄDU	BE50910106	3418 T10098 T20038	
KLUCZ PODWÓJNY 1	BE50910107	2587 Matra V159 U30009	
TRZPIEŃ BLOKUJĄCY POMPY WTRYSKOWEJ	BE50910108	2064 U20003	
KLUCZ PODWÓJNY 2	BE50910109	T10020	
NAPINACZ ŁAŃCUCHA/ROZRZĄDU 1	BE50910110	3366 T20018	
NAPINACZ ŁAŃCUCHA/ROZRZĄDU 2	BE50910111	T10092	
TRZPIEŃ NAPINACZA PASKA NAPĘDOWEGO	BE50910112	T10060	
TRZPIEŃ BLOKADY NAPINACZA ŁAŃCUCHA	BE50520302	T40011	
ŚRUBA M5	BE50910114	/	

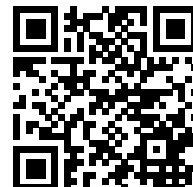

Składniki

NARZĘDZIE DO USTAWIANIA ROZRZĄDU

BE50910206

T10123



UCHWYT CZUJNIKA

BE50910207

T10170

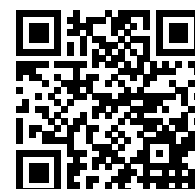
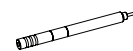

KOMPLETNY ZESTAW NARZĘDZI PASUJĄCY DO GRUPY VW 1.2 TSI BENZYNA



Kompletne zestawy

BE509103

Marka	Model	Silnik	Kod silnika
VW	Polo, Caddy, Caddy Maxi, Golf, Golf plus, Golf estate	1.2 TSi	CBZA, CBZC
	Touran, Caddy, Caddt maxi, Golf, Golf plus, Golf estate, Jetta, Golf VI cabrio		CBZB
AUDI	A1		CBZA, CBZC
	A3, A3 cabrio		CBZB

Składniki

NARZĘDZIE DO BLOKADY WAŁU

BE50910203

T10340

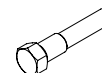

NARZĘDZIE DO USTAWIANIA ROZRZĄDU

BE50910302

T10414

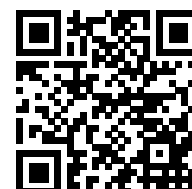

KOMPLETNY ZESTAW NARZĘDZI PASUJĄCY DO GRUPY VW 1.0 ECOBOOST BENZYNA



Kompletne zestawy

BE509104

Marka	Model	Silnik	Kod silnika	Rok
VW	Up	1.0	CHYA	2012-2014
		1.0	CHYB	2012-2014
		1.0 Bluemotion Technology	CHYA	2012-2014
		1.0 Bluemotion Technology	CHYB	2012-2014
		1.0 Ecofuel	CPGA	2012-2014
SEAT	Mii	1.0	CHYA	2012-2014
		1.0	CHYB	2012-2014
		1.0 Ecofuel	CPGA	2012-2014
		1.0 Ecomotive	CHYA	2012-2014
		1.0 Ecomotive	CHYB	2012-2014
ŠKODA	Citigo	1.0	CHYA	2012-2014
		1.0	CHYB	2012-2014
		1.0 Ecofuel	CPGA	2012-2014
		1.0 Green Tech	CHYA	2012-2014
		1.0 Green Tech	CHYB	2012-2014

Składniki

NARZĘDZIE DO NAPINACZA KOŁA PASOWEGO

BE50910401

T10499

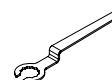

NARZĘDZIE BLOKUJĄCE KOŁO ZĘBATE ROZRZĄDU

BE50910402

T10476



NARZĘDZIE BLOKUJĄCE WAŁ

BE50910403

T10477

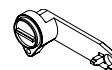

Składniki

NARZĘDZIE DO ODKRĘCANIA/ZAKRĘCANIA
ŚRUBY KOŁA PASOWEGO NAPINACZA

BE50910404

T10500

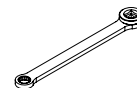

TRZPIEŃ DO WAŁU

BE50910203

T10340

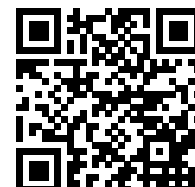

KOMPLETNY ZESTAW NARZĘDZI PASUJĄCY DO GRUPY VW 1.2-1.4- 1.6-1.9-2.0 DIESEL



Kompletne zestawy

BE509205

Marka	Model	Silnik	Kod silnika
AUDI	A3	2.0 TDI CR	CBBB
	Tt	2.0 TDI CR	CBBB
	A3	2.0 TDI CR	CBAA
	A3 Cabrio	2.0 TDI CR	CBAA
	A3	2.0 TDI CR	CBAB
	A3 Cabrio	2.0 TDI CR	CBAB
	A3	2.0 TDI CR	CFFB
	A3 Cabrio	2.0 TDI CR	CFFB
	Q3	2.0 TDI CR	CFFB
	A4	2.0 TDI CR	CAGC
	A5 Coupe/Cabriolet	2.0 TDI CR	CAGC
	A1	1.6 TDI CR	CAYB
	A3	1.6 TDI CR	CAYB
	A4	2.0 TDI CR	CAGA
	A4 Allroad	2.0 TDI CR	CAGA
	A4 Quattro	2.0 TDI CR	CAGA
	A5 Coupe/Cabriolet	2.0 TDI CR	CAGA
	A5 Sportback	2.0 TDI CR	CAGA
	Q5	2.0 TDI CR	CAGA
	A4	2.0 TDI CR	CAGB
	A4 Allroad	2.0 TDI CR	CAGB
	A5 Coupe/Cabriolet	2.0 TDI CR	CAGB
	A5 Sportback	2.0 TDI CR	CAGB
	A6	2.0 TDI CR	CAGB
	Q5	2.0 TDI CR	CAGB
	A4	2.0 TDI CR	CAHA
A4 Allroad	2.0 TDI CR	CAHA	
A4 Quattro	2.0 TDI CR	CAHA	
FORD	Galaxy	1.9TDI PD	ASZ
	Galaxy	1.9TDI PD	ANU
	Galaxy	1.9TDI PD	AUY

Marka	Model	Silnik	Kod silnika
SEAT	Altea/Altea XL	1.6 TDI CR	CAYC
	Ibiza	1.6 TDI CR	CAYC
	Leon	1.6 TDI CR	CAYC
	Toledo	1.6 TDI CR	CAYC
	Alhambra	2.0 TDI CR	CFFB
	Exeo	2.0 TDI CR	CAGC
	Altea/Altea XL	1.6 TDI CR	CAYB
	Ibiza	1.6 TDI CR	CAYB
	Leon	1.6 TDI CR	CAYB
ŠKODA	Fabia II	1.6 TDI CR	CAYC
	Octavia II	1.6 TDI CR	CAYC
	Rapid	1.6 TDI CR	CAYC
	Rapid Spaceback	1.6 TDI CR	CAYC
	Roomster	1.6 TDI CR	CAYC
	Superb II	1.6 TDI CR	CAYC
	Superb II	2.0 TDI CR	CBBB
	Superb II	2.0 TDI CR	CFFB
	VW	Beetle/Maggiolino	1.6 TDI CR
Golf Plus		1.6 TDI CR	CAYC
Golf VI Cabrio		1.6 TDI CR	CAYC
Jetta		1.6 TDI CR	CAYC
Polo		1.6 TDI CR	CAYC
Touran		1.6 TDI CR	CAYC
Golf VI		2.0 TDI CR	CBBB
Passat		2.0 TDI CR	CBBB
Passat CC		2.0 TDI CR	CBBB
Scirocco		2.0 TDI CR	CBBB
Tiguan		2.0 TDI CR	CBBB
Golf VI		2.0 TDI CR	CBAA
Passat		2.0 TDI CR	CBAA
Passat CC		2.0 TDI CR	CBAA

Sprawdź wszystkie zastosowania w instrukcji obsługi

Składniki

TRZPIEŃ ROZRZĄDU/POMPY WTRYSKOWEJ

BE50910103

3359

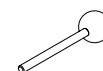

PRZYRZĄD DO BLOKOWANIA NAPINACZA

BE50920602

T10008



NARZĘDZIE BLOKADY WAŁU (OKRĄGŁE)

BE50920603

T10050



KOMPLETNY ZESTAW NARZĘDZI PASUJĄCY DO GRUPY VW 1.9-2.0 DIESEL



Kompletne zestawy

BE509206

Marka	Model	Silnik	Kod silnika
AUDI	A3, A4, A4 Cabrio, A4 4WD, A6	1.9D TDI PD	BKE, BLS, BRB, BXE
		2.0D TDI PD	AZV, BKD, BLB, BMM, BMN, BNA, BPW, BRC, BRD, BRE, BRF, BUY, BVA, BVF, BVG
SEAT	Alhambra, Altea/Altea XL, Leon, Toledo	1.9D TDI PD	ARL, ASZ, ATD, AXR, BJB, BKC, BLT, BMT, BPX, BUK, BXE
		2.0D TDI PD	BMM, BMN
ŠKODA	Octavia, Octavia II, Superb, Superb II	1.9D TDI PD	BJB, BKC, BLS, BXE
		2.0D TDI PD	AZV, BKD, BMM, BMP, BSS
VW	Bora, Caddy, Caddy Maxi, Eos, Golf, Golf Estate, Golf Plus, Jetta, Passat, New Beetle, Sharan, Touran, Transporter	1.9D TDI PD	AVQ, AXB, AXC, AXR, BJB, BKC, BLS, BLT, BMT, BRM, BRR, BRS, BRU, BSU, BSW, BXE, BXF, BXJ
		2.0D SDI	BDJ, BST
		2.0D TDI PD	AZV, BKD, BKP, BMA, BMM, BMN, BMP, BMR, BRT, BUZ, BVE, BVH, BWV

Składniki

TRZPIEŃ ROZRZĄDU/POMPY WTRYSKOWEJ

BE50910103

3359

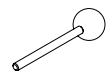

PRZYRZĄD DO BLOKOWANIA NAPINACZA

BE50920602

T10008



NARZĘDZIE BLOKADY WAŁU (OWALNE)

BE50920703

T10100

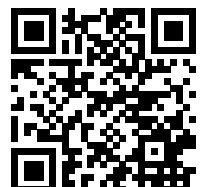

KOMPLETNY ZESTAW NARZĘDZI PASUJĄCY DO GRUPY VW 1.2-1.4- 1.6-1.9-2.0 DIESEL

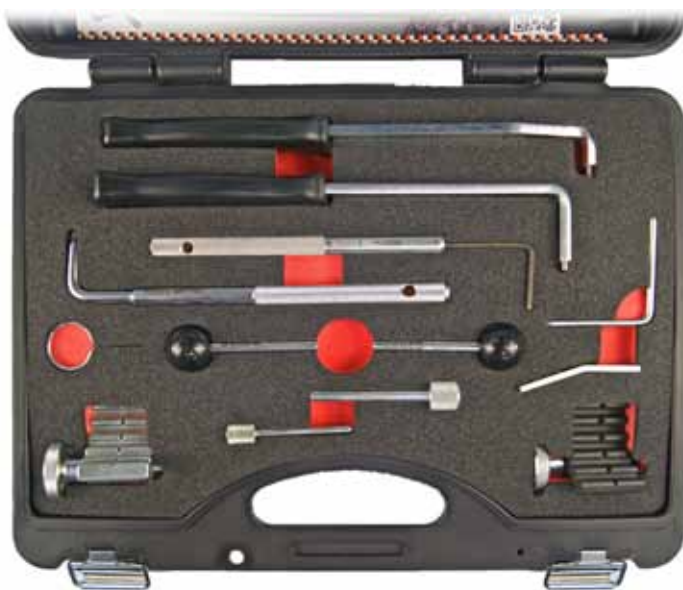









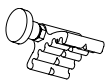

Kompletne zestawy

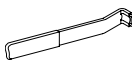
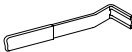
BE509207

Marka	Model	Silnik	Kod silnika
VW	Beetle, New Beetle, Bora, Caddy, Caddy Maxi, Eos, Fox, Golf, Golf Plus, Golf Estate, Jetta, Jetta III, Lupo, Passat, Passat CC, Polo, Scirocco, Sharan, Tiguan, Touran, Transporter	1.2D TDI PD	ANY, AYZ
		1.4D TDI PD	AMF, BMS, BNM, BNV, BWB, BAY
		1.6D TDI CR	CAYA, CAYB, CAYC
		1.9D TDI PD	AJM, ARL, ASZ, ATD, ANU, AUY, ATJ, AVB, AWX, AVF, AVQ, BJB, BKC, BLS, BRM, BSU, AXB, AXC, BRR, BRS, BLT, BRU, BMT, AXR, BSW, BTB, BVK, BXE, BXF, BXJ
		2.0D SDI	BDK, BDJ
		2.0D TDI CR	CAAA, CBAA, CBAB, CBAC, CBBA, CBBB, CBDA, CBDB, CBDC, CBDD, CCHA, CEGA, CJAA, CAAB, CAAC
		2.0D TDI PD	AZV, BKD, BUZ, BVE, BGW, BHW, BKP, BMA, BMM, BMN, BMR, BWV, BMP, BRT, BVH
AUDI	A1, A2, A3, A3 Cabrio, A4, A4 quattro, A5 Coupe/Cabriolet, A6, A6 quattro, Q5, TT	1.2D TDI PD	ANY
		1.4D TDI PD	AMF, ATL, BHC
		1.6D TDI CR	CAYB, CAYC
		1.9D TDI PD	ASZ, ATD, AXR, BKC, AVB, AVF, AWX, BKE, BRB, BLS, BXE
		2.0D TDI CR	CAGA, CAGB, CAGC, CAHA, CAHB, CBAA, CBAB, CBBB, CFFB, CGLA, CGLB, CJCA, CJCB
		2.0D TDI PD	AZV, BKD, BKQ, BRA, BUY, BLB
AUDI	A1, A2, A3, A3 Cabrio, A4, A4 quattro, A5 Coupe/Cabriolet, A6, A6 quattro, Q5, TT	2.0D TDI PD	BMM, BMN, BNA, BRD, BRE, BRF, BVA, BVF, BVG, BPW, BRC
SEAT	Alhambra, Altea, Altea XL, Arosa, Cordoba, Ibiza, Inca, Leon, Toledo	1.4D TDI PD	AMF, BMS, BNM, BNV
		1.9D TDI PD	ARL, ASZ, ATD, AXR, BJB, BLT, BMT, BPX, BUK, BKC, BJB, BXE, BLS
		2.0D TDI CR	CAGA, CAHA, CFHC, CEGA, CFJA
		2.0D TDI PD	AZV, BKD, BMM, BMN
ŠKODA	Exeo, Fabia, Fabia II, Octavia, Octavia Tour, Octavia II, Roomster, Superb, Superb II	1.4D TDI PD	AMF, BMS, BNM, BNV
		1.6D TDI CR	CAYA, CAYB, CAYC
		1.9D TDI PD	ASZ, ATD, BSV, AXR, BLT, BJB, BKC, BXE, BLS, BSW
		2.0D TDI CR	CBBB, CBDB, CEGA, CFHC
		2.0D TDI PD	AZV, BKD, BMM, BMP, BSS

Składniki

TRZPIEŃ ROZRZĄDU/POMPY WTRYSKOWEJ	BE50910103	3359	
PRZYRZĄD DO BLOKOWANIA NAPINACZA	BE50920602	T10008	
NARZĘDZIE BLOKADY WAŁU (OWALNE)	BE50920703	T10100	
NARZĘDZIE BLOKADY WAŁU (OKRĄGŁE)	BE50920603	T10050	
TRZPIEŃ NAPINACZA PASKA NAPĘDOWEGO	BE50910112	T10060	
KLUCZ PODWÓJNY 2	BE50910109	T10020	
KLUCZ PODWÓJNY 3	BE50920707	3387 U30009A	
NARZĘDZIE ROLKI NAPINACZA	BE50920708	T10264	
NARZĘDZIE BLOKUJĄCE ROLKI NAPINACZA	BE50920709	T10265	
TRZPIEŃ NAPINACZA PASKA NAPĘDOWEGO	BE50920710	T10060A T40098	
TRZPIEŃ BLOKADY NAPINACZA	BE50920711	T10115	
TRZPIEŃ BLOKADY NAPINACZA	BE50510102	303-1054 T10015	

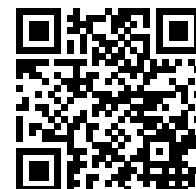



VOLVO

SILNIKI BENZYNOWE

BE510101

1.6 - 1.8 - 1.9 - 2.0 - 2.3 - 2.4 - 2.5 twin cams

66

BE510102

1.6 - 1.8 - 2.0 16V. twin cams

68

SILNIKI DIESELA

BE510203

Silniki 1.6 - 2.0

70

BE510304

Narzędzie do podtrzymywania wału

72

KOMPLETNY ZESTAW NARZĘDZI PASUJĄCY DO VOLVO 1.6 - 1.8 - 1.9 - 2.0 - 2.3 - 2.4 - 2.5 PETROL





Kompletne zestawy

BE510101

Marka	Model	Silnik	Kod silnika
VOLVO	850, C70, S40, V40, S60, S70, S80	1.6, 1.8, 1.9, 2.0, 2.3, 2.4, 2.5 TWIN CAMS	B4164S
			B4164S2
			B4184S
			B4184S2
			B4184S3
			B4184S9
			B4184S10
			B4194T
			B4194T2
			B4204S
			B4204S2
			B4204T
			B4204T2
			B4204T3
			B4204T5
			B5202FS
			B5204FT
			B5204T2
			B5204T3
			B5204T4
			B5204T5
			B5234FS
			B5234FT
			B5234T3
			B5234T4
			B5234T5
B5234T6			
B5234T7			
B5234T8			
B5234T9			

Marka	Model	Silnik	Kod silnika
VOLVO	850, C70, S40, V40, S60, S70, S80	1.6, 1.8, 1.9, 2.0, 2.3, 2.4, 2.5 TWIN CAMS	B5244S
			B5244S2
			B5244SG
			B5244SG2
			B5244T
			B5244T3
			B5244T4
			B5244T5
			B5244T7
			B5252FS
			B5254T
			B5254T2
			B5254T4
RENAULT	Laguna, Safrane	2.0 16V, 2.5 20V	N7Q 704/710/711
			N7U 700/701

Składniki

TRZPIEŃ BLOKADY WAŁU	BE51010101	MOT 1340 999-5451	
NARZĘDZIE BLOKADY ROZRZĄDU	BE51010102	MOT 1337 999-5452	
DODATKOWE NARZĘDZIE NACIĄGU	BE51010103	MOT 1348	

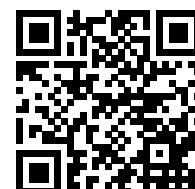

KOMPLETNY ZESTAW NARZĘDZI PASUJĄCY DOR VOLVO 1.6 - 1.8 - 2.0 16V. PETROL



Kompletne zestawy

BE510102

Marka	Model	Silnik	Kod silnika	Rok
VOLVO	C30	1.6	B4164S3	2006-2012
		1.8	B4184S11	2006-2010
		2.0	B4204S3	2006-2013
	S40	1.6	B4164S3	2004-2012
		1.8	B4184S11	2004-2010
		2.0	B4204S3	2006-2012
	S80	2.0	B4204S3	2007-2011
	V50	1.6	B4164S3	2004-2012
		1.8	B4184S11	2004-2010
		2.0	B4204S3	2006-2012
V70	2.0	B4204S3	2007-2011	
FORD	C-MAX	1.6	HWDA	2007-2010
		1.6	HWDB	2007-2010
		1.8	CSDA	2007-2010
		1.8	QQDA	2007-2010
		1.8	QQDB	2007-2010
		1.8	QQDC	2007-2010
		2.0	AODA	2007-2010
		2.0	AODB	2007-2010
	Cougar	2.0	EDBA/C	1998-2001
		2.0	EDBB	2000-2001
		2.0	EDBD	1999-2001
	Fiesta	1.25	F8JA	2002-2008
		1.25	F8JB	2002-2008
		1.25	FUJA	2002-2008
		1.25	FUJB	2002-2008
		1.25	M7JA	2002-2008
		1.25	M7JB	2002-2008
		1.4	FXJA	2002-2008
		1.4	FXJB	2002-2008
	1.6	FYJA	2002-2008	

Marka	Model	Silnik	Kod silnika	Rok
FORD	Fiesta	1.6	FYJB	2003-2008
		2.0	N4JB	2004-2008
		2.0	N4JB	2007-2008
		1.4	FHA	1995-2000
		1.4	FHA	1995-2000
		1.4	FHE	1995-2000
		1.4	FHE	1995-2000
		1.6	L1T	2000-2002
		1.6	L1V	2000-2002
	Focus	1.4	ASDA	2005-2011
		1.4	ASDB	2005-2011
		1.4	FXJA	2004-2011
		1.6	HWDA	2004-2011
		1.6	HWDB	2005-2011
		1.8	QQDB	2004-2011
		1.8	QQDA	2006-2011
		2.0	AODA	2004-2011
		2.0	AODA	2004-2011
		2.0	AODB	2004-2011
		2.0	AODB	2004-2011
		1.4	FXDA/C	1998-2005
		1.4	FXDB/D	2000-2005
		1.6	FYDA/C	1998-2005
		1.6	FYDB/D	2000-2005
1.8	EYDB	2000-2005		

Sprawdź wszystkie zastosowania w instrukcji obsługi

Składniki

TRZPIEŃ BLOKUJĄCY	BE51010201	21-210 303-507 999-7152	
TRZPIEŃ BLOKADY WAŁU	BE51010202	21-163 303-574 999-7201	
TRZPIEŃ DO WAŁU	BE50510105	303-748 21-226 21-259	
USTAWIENIE PASKA ROZRZĄDU	BE50510106	303-376 303-376B 21-162B 303-367	
TRZPIEŃ BLOKADY NAPINACZA	BE50510102	303-1054 T10015	



KOMPLETNY ZESTAW NARZĘDZI PASUJĄCY DO VOLVO 1.6 - 2.0 DIESEL



Kompletne zestawy

BE510203

Marka	Model	Silnik	Kod silnika	Rok	
CITROËN	Dispatch/Jumpy III	1.6	9HU (DV6UTED4)	2007-2012	
	C4	2.0	RHR (DW10BTED4)	2004-2011	
	C4 Picasso/Grand Picasso	2.0	RHR (DW10BTED4)	2006-2011	
	C5 II		2.0	RHR (DW10BTED4)	2004-2008
			2.2	4HP (DW12BTED4)	2007-2008
			2.2	4HR (DW12BTED4)	2007-2008
			2.2	4HS (DW12BTED4)	2007-2008
			2.2	4HT (DW12BTED4)	2006-2008
	C5 III		2.0	RHR (DW10BTED4)	2007-2010
			2.2	4HP (DW12BTED4)	2007-2009
			2.2	4HT (DW12BTED4)	2007-2009
			2.2	4HT (DW12BTED4)	2007-2008
	C6		2.2	4HP (DW12BTED4)	2007-2011
			2.2	4HS (DW12BTED4)	2007-2011
			2.2	4HT (DW12BTED4)	2006-2011
			2.0	RHK (DW10UTED4)	2006-2010
			2.0	RHR (DW10BTED4)	2006-2010
			2.2	4HP (DW12BTED4)	2007-2010
	C8		2.2	4HR (DW12BTED4)	2007-2010
			2.2	4HS (DW12BTED4)	2007-2010
2.2			4HT (DW12BTED4)	2007-2010	
2.0			RHK (DW10UTED4)	2007-2012	
2.0			RHK (DW10UTED4)	2009-2011	
2.0			RHR (DW10BTED4)	2007-2012	
2.0			RHR (DW10BTED4)	2009-2011	
2.0			RHR (DW10BTED4)	2009-2011	
FIAT	Scudo	1.6	9HU (DV6UTED4)	2007-2012	
		1.6	9H07	2011-2014	
		2.0	RHK (DW10UTED4)	2007-2012	
		2.0	RHK (DW10UTED4)	2009-2011	
		2.0	RHR (DW10BTED4)	2007-2012	

Marka	Model	Silnik	Kod silnika	Rok
FIAT	Scudo	2.0	RHR (DW10BTED4)	2009-2011
		1.6	G8DA	2007-2010
		1.6	G8DB	2007-2010
		1.6	G8DC	2007-2010
		1.6	G8DD	2008-2010
		1.6	G8DE	2010-2010
		1.6	G8DF	2010-2010
		1.6	HHDA	2007-2010
		1.6	HHDB	2007-2010
FORD	Fiesta	1.4	F6JA	2002-2008
		1.4	F6JB	2003-2008
		1.4	F6JC	2002-2008
		1.6	HHJA	2004-2008
		1.6	HHJB	2005-2008
		1.4	F6JD	2008-2011
		1.6	HHJC	2008-2011
		1.6	HHJD	2008-2011
		1.6	HHJE	2008-2011
		1.6	HHJF	2008-2011
		1.6	HHJD	2008-2011
		1.6	G8DD	2007-2011

Sprawdź wszystkie zastosowania w instrukcji obsługi

Składniki

NARZĘDZIE BLOKUJĄCE KOŁO ZĘBATE ROZRZĄDU	BE50420102	0194-A; 11 9 790; 21-260; 303-732; 999-7233; 2000023000; 2000023100	
NARZĘDZIE DO BLOKOWANIA KOŁA ZAMACHOWEGO	BE50420103	0194-C; 303-734; 21-262; 2000022500; 999-7169	
NARZĘDZIE DO USTAWIANIA WAŁU	BE50420104	0194-B; 11 9 790; 303-735; 21-263; 2000023200; 999-7122	
TRZPIEŃ NAPINAJĄCY KOŁO ZAMACHOWE	BE50520411	0188-X; 303-1059; 303-1270; 999-7121	
NARZĘDZIE DO BLOKOWANIA KOŁA ZAMACHOWEGO	BE50510104	303-393; 21-168; 303-1272	
NARZĘDZIE DO BE50510104	BE50520407	303-393-1	



NARZĘDZIE DO PODTRZYMYWANIA WAŁU PASUJE DO VOLVO



Kompletne zestawy

BE510304

Marka	Model	Silnik	Kod silnika	Rok	
VOLVO	C30	2.0	D5204T5	2010-2013	
		2.0	D5204T	2010-2013	
		2.4	D5244T9	2006-2010	
		2.4	B5244S4	2006-2010	
		2.4	B5244S5	2006-2009	
		2.4	B5244S7	2006-2009	
		2.4	D5244T13	2007-2010	
		2.4	D5244T8	2006-2010	
		2.4	D5244T13	2009-2010	
		2.4	D5244T8	2009-2010	
		2.5	B5254T3	2006-2007	
		2.5	B5254T7	2007-2013	
		2.5	B5254T3	2007-2007	
		2.5	B5254T7	2008-2013	
		C70	2.0	D5204T5	2010-2013
	2.0		D5204T	2010-2013	
	2.4		D5244T9	2006-2010	
	2.4		B5244S4	2006-2010	
	2.4		B5244S5	2006-2010	
	2.4		D5244T13	2007-2010	
	2.4		D5244T8	2006-2010	
	2.4		D5244T13	2009-2010	
	2.4		D5244T8	2009-2010	
	2.5		B5254T3	2006-2007	
	2.5		B5254T7	2007-2013	
	2.5		B5254T3	2007-2007	
	2.5		B5254T7	2007-2013	
	S40		2.0	D5204T5	2010-2012
			2.0	D5204T	2010-2012
		2.4	D5244T9	2006-2010	
2.4		B5244S4	2003-2010		
2.4		B5244S5	2003-2010		

Dalsze

Marka	Model	Silnik	Kod silnika	Rok
VOLVO	S40	2.4	B5244S5	2003-2010
		2.4	B5244S7	2006-2009
		2.4	D5244T13	2007-2010
		2.4	D5244T8	2006-2010
		2.5	B5254T3	2003-2008
		2.5	B5254T3	2003-2008
		2.5	B5254T7	2007-2012
	S60	2.4	D5244T5	2005-2009
		2.4	D5244T6	2005-2006
		2.4	D5244T7	2005-2009
		2.4	D5244T4	2005-2009
		2.0	D5204T2	2010-2011
		2.0	D5204T7	2012-2014
		2.0	D5204T3	2011-2014
		2.4	D5244T10	2010-2011
		2.4	D5244T11	2011-2014
		2.4	D5244T15	2011-2012
		2.4	D5244T15	2012-2014
		2.4	D5244T11	2013-2014
		2.4	D5244T15	2013-2014
		2.5	B5254T5	2010-2012
		S80	2.0	D5204T2
	2.0		D5204T7	2012-2014
	2.0		D5204T3	2011-2014
	2.4		D5244T14	2009-2010
	2.4		D5244T19	2009-2010
	2.4		D5244T5	2006-2009
	2.4		D5244T10	2008-2011
	2.4		D5244T11	2011-2014
	2.4		D5244T15	2011-2014
	2.4		D5244T4	2006-2009
	2.4		D5244T4	2006-2009
	2.5		B5254T11	2009-2011
	2.5		B5254T8	2008-2011
	2.5		B5254T10	2009-2012
	2.5	B5254T6	2006-2009	

Sprawdź wszystkie zastosowania w instrukcji obsługi

Składniki

NARZĘDZIE DO PODTRZYMYWANIA WAŁU

BE510304

999-5433
303-1179

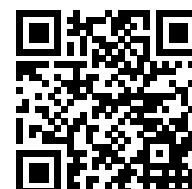
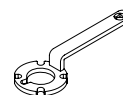

NARZĘDZIA DO SILNIKA

ŚWIECE

ELEKTRODA

BE513201

M8X1 - M9X1 - M10X1 - M10X1.25

KOMPLETNY ZESTAW DO ŚWIEC ŻAROWYCH M8X1 - M9X1 - M10X1 - M10X1.25



Premium

Kompletne zestawy

BE513201

ZASTOSOWANIE

Zestaw zawiera wszystkie niezbędne narzędzia, aby bezpiecznie usunąć część wymienną świecy żarowej bez uszkodzenia głowicy. Taka operacja staje się bardzo prosta i szybka. Jest to alternatywa do demontażu całej głowicy, co jest znaczną oszczędnością czasu.

Narzędzia **BE51320114**, **BE51320113**, **BE51320112** umożliwiają usunięcie końcówek świec żarowych, jak pokazano w tabeli poniżej „Zastosowanie”. Takie silniki są wyposażone w świece żarowe M8x1, w których charakterystyczne jest to, że końcówki są takie same jak w świecach żarowych M10.







Marka	Model	Silnik	Kod silnika	kW
CITROËN	Xsara	1.4 HDI	8HX (DV4TD)	50
	Xsara Break	1.4 HDI	8HX (DV4TD)	50
	Xsara Coupe	1.4 HDI	8HX (DV4TD)	50
	Xsara Picasso	1.6 HDI	DV6TED4	80
	Berlingo	1.6 HDI 90	DV6ATED4	66
	C2	1.4 HDI	8HX (DV4TD)	50
	C2	1.6 HDI	9HZ (DV6TED4)	80
	C3 (FC_)	1.4 HDI	8HX (DV4TD)	50
	C3 (FC_)	1.4 HDI 16V	8HY (DV4TED4)	66
	C3 (FC_)	1.6 HDI 16V	DV6TED4	66
	C3 (FC_)	1.6 HDI 16V	DV6TED4	80
	C3 Pluriel	1.4 HDI	8HX (DV4TD)	50
	C4 Coupe	1.6 HDI 110 FAP	DV6TED4	80
	C4 Grand Picasso	1.6 HDI 110 FAP	9HY (DV6TED4), 9HZ (DV6TED4)	80
	C5	1.6 HDI	DV6TED4	80
C5 Break (RE)	1.6 HDI	9HY (DV6TED4)	80	
FORD	C-Max	1.6 TDCI	HHDA, HHDB	66
	C-Max	1.6 TDCI	G8DA, G8DB	80
	C-Max	1.6 TDCI	GPDA, HHDA, HHDB	66
	C-Max	1.6 TDCI	G8DA, G8DB, G8DD	80
	Fiesta V	1.4 TDCI	F6JA, F6JB	50
	Focus C-Max	1.6 TDCI	HHDA, HHDB	66
	Focus C-Max	1.6 TDCI	G8DA, G9DB	80
	Focus II	1.6 TDCI	HHDA, HHDB	66
	Focus II	1.6 TDCI	G8DA, G8DB	80

Dalsze

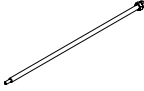
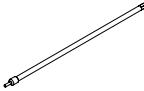
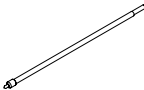
Marka	Model	Silnik	Kod silnika	kW
FORD	Fusion	1.4 TDCI	F6JA, F6JB	50
	Fusion	1.6 TDCI	HHJA, HHJB	66
MAZDA	2	1.4 CD	F6JA	50
SUZUKI	Liana / Kombi	1.4 DDIS	8HY	66
TOYOTA	Aygo	1.4 HDI	2WZ-TV	40

Sprawdź wszystkie zastosowania w instrukcji obsługi

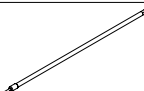
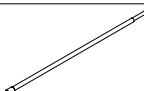
Składniki

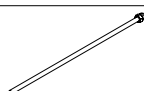
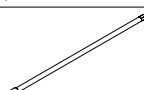
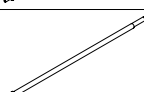
M4 PRĘT Z NAKRĘTKĄ	BE51320101	
M4 PRĘT Z PRZEDŁUŻKĄ	BE51320102	
3,2 Ø PRĘT Z PRZEDŁUŻKĄ	BE51320103	
M10X1 KLUCZ DO ŚWIEC	BE51320104	
M10 ŚCIĄGACZ ŚLIZGOWY DO ŚWIEC	BE51320105	
M10X1,25 KLUCZ DO ŚWIEC	BE51320106	
M3 KOŃCÓWKA Z NAKRĘTKĄ	BE51320107	
M3 KOŃCÓWKA Z PRZEDŁUŻENIEM	BE51320108	
2,5 Ø KOŃCÓWKA Z PRZEDŁUŻENIEM	BE51320109	
M9X1 KLUCZ DO ŚWIEC	BE51320110	
M8X1 KLUCZ DO ŚWIEC	BE51320111	
M4 KOŃCÓWKA Z NAKRĘTKĄ (SPECJALNE ZASTOSOWANIE)	BE51320112	
M4 KOŃCÓWKA Z PRZEDŁUŻENIEM (SPECJALNE ZASTOSOWANIE)	BE51320113	
3,2 Ø KOŃCÓWKA Z PRZEDŁUŻENIEM (SPECJALNE ZASTOSOWANIE)	BE51320114	





WTRYSKI

UNIVERSAL

BE512201

UNIWERSALNE NARZĘDZIE DO WYMIANY WTRYSKÓW

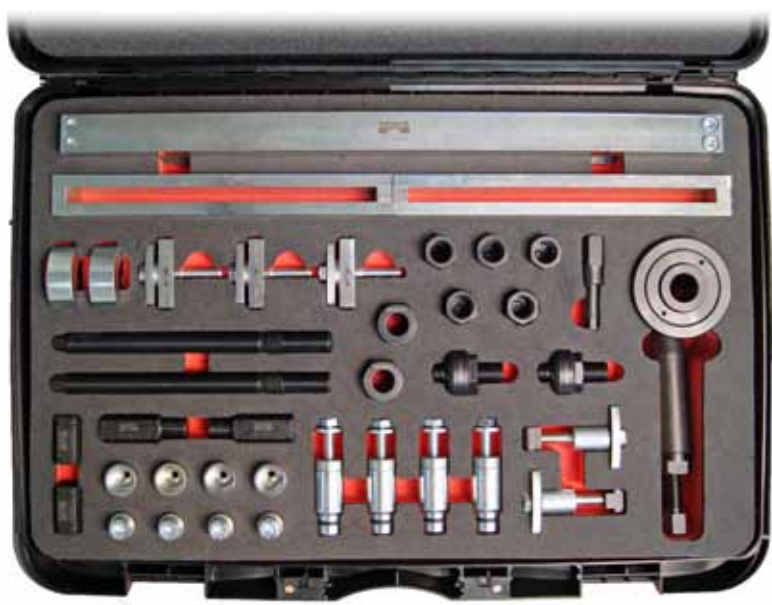

Premium

Kompletne zestawy

BE512201

ZASTOSOWANIE









Typowe do demontażu bardzo zablokowanych wtryskiwaczy.

Często wtryskiwacz jest zablokowany w swoim gnieździe ze względu na zanieczyszczenia spowodowane przez spaliny i nie może być usunięty bez odpowiednich narzędzi.

Wtryskiwacz jest wyciągany mechanicznie i hydraulicznie dzięki zastosowaniu uniwersalnego ściągacza zaadaptowanego do różnych głowic i specjalnego płaskiego hydraulicznego cylindra (opcja).

Zastosowanie cylindra i poprzeczki, zapewnia/pozwała na skalibrowane zdjęcie prostopadłe do wtryskiwacza.

Składniki

ZESTAW CENTRUJĄCY	BE51220101	
HYDROMECHANICZNY CYLINDER	BE51220102	
PŁYTA PODTRZYMUJĄCA	BE51220103	
REGULOWANA PODSTAWA	BE51220104	
ŚRUBA M18X1.5 L = 220 MM	BE51220105	
KLUCZ 10 MM	BE51220106	
NAKRĘTKA M18X1.5	BE51220107	
PODSTAWA PRZEDŁUŻKA	BE51220108	
DOLNE PODSTAWA	BE51220109	

Dalsze

Składniki

REGULOWANA PRZEDŁUŻKA	BE51220110	
PODKŁADKA Z ŁOŻYSKIEM	BE51220111	
KRZYŻAK	BE51220112	
ŚRUBA M18X1.5 Z PODWÓJNYM POŁĄCZENIEM BOSCH	BE51220113	
GWINTOWANY ADAPTER M14X1.5 DELPHI	BE51220114	
GWINTOWANY ADAPTER M16X1 TOYOTA	BE51220115	
GWINTOWANY ADAPTER M20X1 DENSO	BE51220116	
GWINTOWANY ADAPTER Ø30 M25X1 SIEMENS	BE51220117	
GWINTOWANY ADAPTER Ø32 M27X1 SIEMENS	BE51220118	
PRZEDŁUŻKA F-F M18X1.5	BE51220119	
PRZEDŁUŻKA M-F M18X1.5	BE51220120	

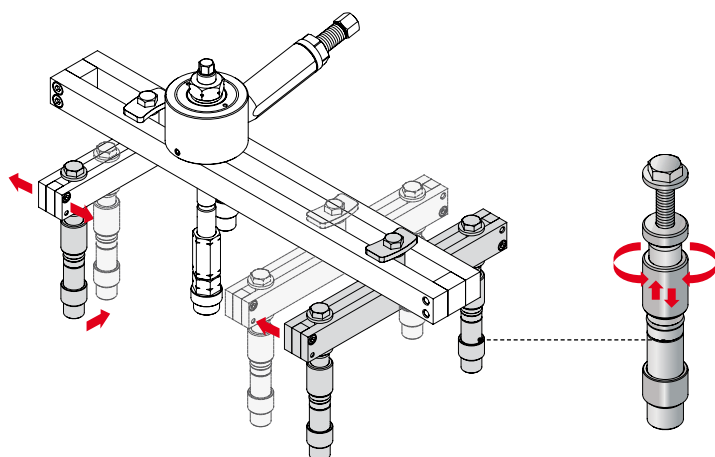

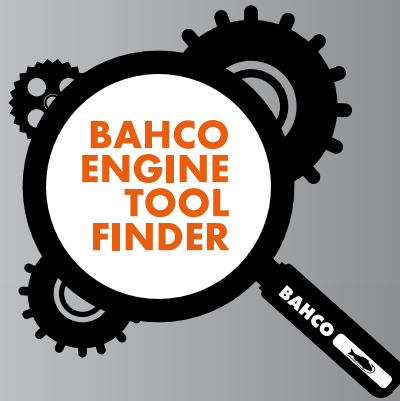

<http://www.bahco.com/enginefinder>



www.bahco.com

SN\Europe IND-1222-POL